

PERFORMANCE
MADE
SMARTER

Product manual

3118

Bipolar isolated converter / splitter

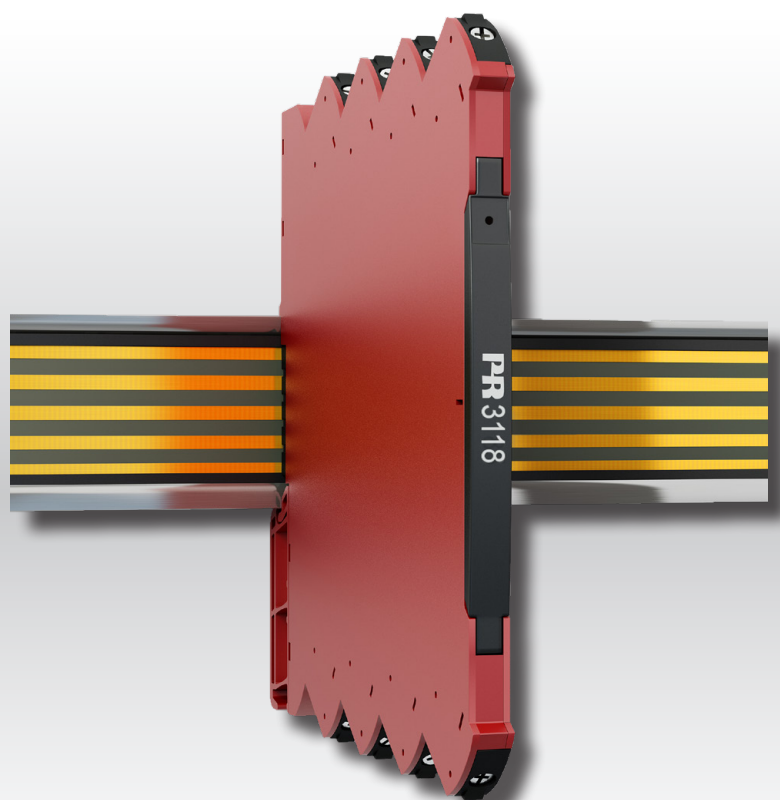

TEMPERATURE | I.S. INTERFACES | COMMUNICATION INTERFACES | MULTIFUNCTIONAL | ISOLATION | DISPLAY

No. 3118V102-UK
From serial no.: 121330001

PR
electronics

6 Product Pillars

to meet your every need

Individually outstanding, unrivalled in combination

With our innovative, patented technologies, we make signal conditioning smarter and simpler. Our portfolio is composed of six product areas, where we offer a wide range of analog and digital devices covering over a thousand applications in industrial and factory automation. All our products comply with or surpass the highest industry standards, ensuring reliability in even the harshest of environments and have a 5-year warranty for greater peace of mind.



Temperature

Our range of temperature transmitters and sensors provides the highest level of signal integrity from the measurement point to your control system. You can convert industrial process temperature signals to analog, bus or digital communications using a highly reliable point-to-point solution with a fast response time, automatic self-calibration, sensor error detection, low drift, and top EMC performance in any environment.



I.S. Interface

We deliver the safest signals by validating our products against the toughest safety standards. Through our commitment to innovation, we have made pioneering achievements in developing I.S. interfaces with SIL 2 Full Assessment that are both efficient and cost-effective. Our comprehensive range of analog and digital intrinsically safe isolation barriers offers multifunctional inputs and outputs, making PR an easy-to-implement site standard. Our backplanes further simplify large installations and provide seamless integration to standard DCS systems.



Communication

We provide inexpensive, easy-to-use, future-ready communication interfaces that can access your PR installed base of products. The detachable 4501 Local Operator Interface (LOI) allows for local monitoring of process values, device configuration, error detection and signal simulation. The next generation, our 4511 Remote Operator Interface (ROI) does all that and more, adding remote digital communications via Modbus/RTU, while the analog output signals are still available for redundancy.

With the 4511 you can further expand connectivity with a PR gateway, which connects via industrial Ethernet, wirelessly through a Wi-Fi router or directly with the devices using our Portable Plant Supervisor (PPS) application. The PPS app is available for iOS, Android and Windows.



Multifunction

Our unique range of single devices covering multiple applications is easily deployable as your site standard. Having one variant that applies to a broad range of applications can reduce your installation time and training, and greatly simplify spare parts management at your facilities. Our devices are designed for long-term signal accuracy, low power consumption, immunity to electrical noise and simple programming.



Isolation

Our compact, fast, high-quality 6 mm isolators are based on microprocessor technology to provide exceptional performance and EMC-immunity for dedicated applications at a very low total cost of ownership. They can be stacked both vertically and horizontally with no air gap separation between units required.



Display

Our display range is characterized by its flexibility and stability. The devices meet nearly every demand for display readout of process signals, and have universal input and power supply capabilities. They provide a real-time measurement of your process value no matter the industry, and are engineered to provide a user-friendly and reliable relay of information, even in demanding environments.

Bipolar isolated converter / splitter 3118

Table of contents

| | |
|--|----|
| Warning | 4 |
| Symbol identification | 4 |
| Safety instructions | 4 |
| Flexible supply | 7 |
| Mounting and demounting of system 3000 | 8 |
| Installation on DIN rail / power rail | 9 |
| Supply of power rail | 9 |
| Marking | 9 |
| Side label | 10 |
| Applications | 11 |
| Technical characteristics | 11 |
| Mounting / installation | 11 |
| Order | 12 |
| Accessories | 12 |
| Accessories for power rail devices | 12 |
| Technical data | 12 |
| Connections | 14 |
| LED indication | 15 |
| DIP-switch configuration | 16 |
| Document history | 17 |

Warning



GENERAL

To avoid the risk of electric shock and fire, the safety instructions of this guide must be observed and the guidelines followed. The specifications must not be exceeded, and the device must only be applied as described in the following. Prior to the commissioning of the device, this installation guide must be examined carefully. Only qualified personnel (technicians) should install this device. If the equipment is used in a manner not specified by the manufacturer, the protection provided by the equipment may be impaired. Until the device is fixed, do not connect hazardous voltages to the device.

To avoid explosion and serious injury: Devices having mechanical failures must be returned to PR electronics for repair or replacement.

Repair of the device must be done by PR electronics A/S only.

Warning



**HAZARDOUS
VOLTAGE**

In applications where hazardous voltage is connected to in-/outputs of the device, sufficient spacing or isolation from wires, terminals and enclosure - to surroundings (incl. neighboring devices), must be ensured to maintain protection against electric shock.

Potential electrostatic charging hazard. To avoid the risk of explosion due to electrostatic charging of the enclosure, do not handle the units unless the area is known to be safe, or appropriate safety measures are taken to avoid electrostatic discharge.



CAUTION

Symbol identification



Triangle with an exclamation mark: Read the manual before installation and commissioning of the device in order to avoid incidents that could lead to personal injury or mechanical damage.



The CE mark proves the compliance of the device with the essential requirements of the directives.



Ex devices have been approved acc. to the ATEX directive for use in connection with installations in explosive areas.

Safety instructions

Receipt and unpacking

Unpack the device without damaging it and check whether the device type corresponds to the one ordered. The packing should always follow the device until this has been permanently mounted.

Environment

Avoid direct sun light, dust, high temperatures, mechanical vibrations and shock, and rain and heavy moisture. If necessary, heating in excess of the stated limits for ambient temperatures should be avoided by way of ventilation.

The device can be used for Measurement Category II and Pollution Degree 2.

The device is designed to be safe at least under an altitude up to 2 000 m.

Mounting

Only technicians who are familiar with the technical terms, warnings, and instructions in the manual and who are able to follow these should connect the device.

Should there be any doubt as to the correct handling of the device, please contact your local distributor or, alternatively,
PR electronics A/S
www.prelectronics.com

Mounting and connection of the device should comply with national legislation for mounting of electric materials, i.e. wire cross section, protective fuse, and location.

Descriptions of input / output and supply connections are shown in this installation guide and on the side label.

The device is provided with field wiring terminals and shall be supplied from a Power Supply having double / reinforced insulation. A power switch should be easily accessible and close to the device. The power switch shall be marked as the disconnecting unit for the device.

SYSTEM 3000 must be mounted on a DIN rail according to EN 60715.

UL installation

Use 60/75°C copper conductors only.

Wire size. AWG 26-12

UL file number E314307

The device is an Open Type Listed Process Control Equipment. To prevent injury resulting from accessibility to live parts the equipment must be installed in an enclosure.

The power Supply unit must comply with NEC Class 2, as described by the National Electrical Code® (ANSI / NFPA 70).

cFMus installation in Division 2 or Zone 2

FM17CA0003X / FM17US0004X Class I, Div. 2, Group A, B, C, D T4 or
Class I, Zone 2, AEx nA IIC T4 or Ex nA IIC T4

In class I, Division 2 or Zone 2 installations, the subject equipment shall be mounted within a tool-secured enclosure which is capable of accepting one or more of Class I, Division 2 wiring methods specified in the National Electrical Code (ANSI/NFPA 70) or in Canada in the Canadian Electrical Code (C22.1).

The 3000 System Isolators and Converters must be connected to limited output NEC Class 2 circuits, as outlined in the National Electrical Code® (ANSI / NFPA 70), only. If the devices are connected to a redundant power supply (two separate power supplies), both must meet this requirement.

Where installed in outdoor or potentially wet locations the enclosure shall at a minimum meet the requirements of IP54.

Warning: Substitution of components may impair suitability for zone 2 / division 2.

Warning: To prevent ignition of the explosive atmospheres, disconnect power before servicing and do not separate connectors when energised and an explosive gas mixture is present.

Warning: Do not mount or remove devices from the power rail when an explosive gas mixture is present.

IECEX, ATEX installation in Zone 2

IECEX KEM 10.0068 X Ex ec IIC T4 Gc

KEMA 10ATEX0147 X II 3 G Ex ec IIC T4 Gc

For safe installation the following must be observed. The device shall only be installed by qualified personnel who are familiar with the national and international laws, directives and standards that apply to this area.

Year of manufacture can be taken from the first two digits in the serial number.

The devices shall be installed in a suitable enclosure providing a degree of protection of at least IP54 according to EN60529, taking into account the environmental conditions under which the equipment will be used.

When the temperature under rated conditions exceeds 70°C at the cable or conduit entry point, or 80°C at the branching point of the conductors, the temperature specification of the selected cable shall be in compliance with the actual measured temperature.

For installation on power rail in Zone 2, only Power Rail type 9400 supplied by Power Control Unit type 9410 is allowed.

To prevent ignition of the explosive atmospheres, disconnect power before servicing and do not separate connectors when energised and an explosive gas mixture is present.

Do not mount or remove devices from the power rail when an explosive gas mixture is present.

Cleaning

When disconnected, the device may be cleaned with a cloth moistened with distilled water.

Liability

To the extent the instructions in this manual are not strictly observed, the customer cannot advance a demand against PR electronics A/S that would otherwise exist according to the concluded sales agreement.

Flexible supply

The technical specifications specifies the maximum required power at nominal operating values, e.g. 24 V supply voltage, 60°C ambient temperature, 600 Ω load, and 20 mA output current.

DIN rail solution - device daisy chain:

The units can be supplied with 24 VDC \pm 30% via direct wiring and a loop between the devices.

Protective fuse: 2.5 A.

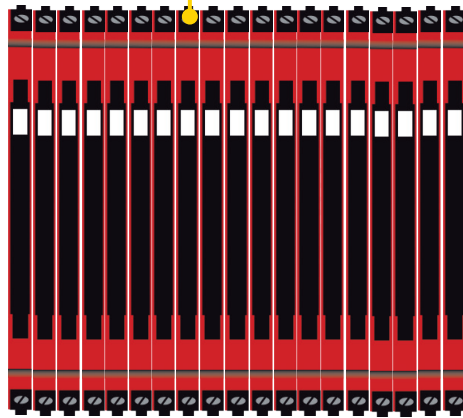

Protective fuse: 0.4 A.

Power rail solution #1:

Alternately, you can connect 24 VDC to any one 3000 device with power rail connector which will then energize other units on the rail.

Note:

3118-N can only be supplied via the DIN rail solution with direct wiring on each device.

External fuse characteristics:

The 2.5 A fuse must break after not more than 120 seconds at 6.4 A.

Power rail solution #2:

The 3405 power connector unit allows easy connection of a 24 VDC / 2.5 A source to the power rail.

Protective fuse: 2.5 A.

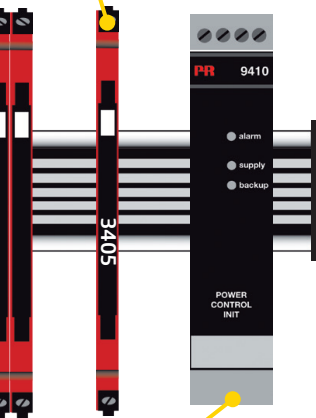

Protective fuse: Located inside the PR 9410.

Power rail solution #3:

The 9410 power control unit can energize and power 96 W to the rail. Redundant power supplies are possible.

Mounting and demounting of system 3000

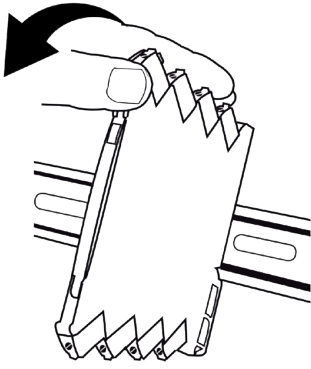

Picture 1:
Mounting on DIN rail / power rail.
Click the device onto the rail.

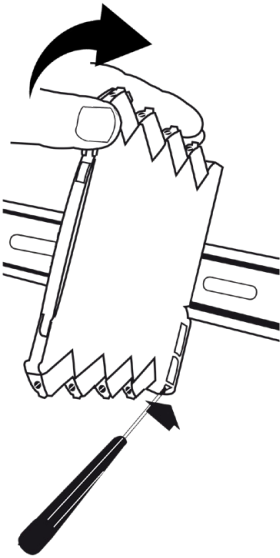

Picture 2:
Demounting from DIN rail / power rail.
First, remember to demount the connectors with hazardous voltages.
Detach the device from the DIN rail by lifting the bottom lock.

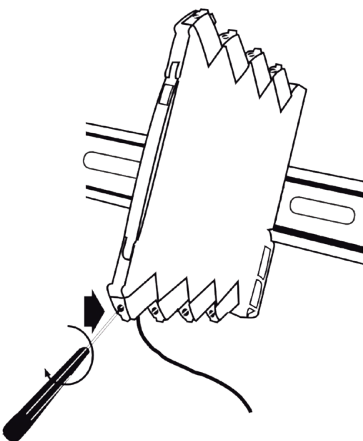

Picture 3:
Wire size AWG 26-12 / 0.13 x 2.5 mm² stranded wire.
Screw terminal torque 0.5 Nm.

Installation on DIN rail / power rail

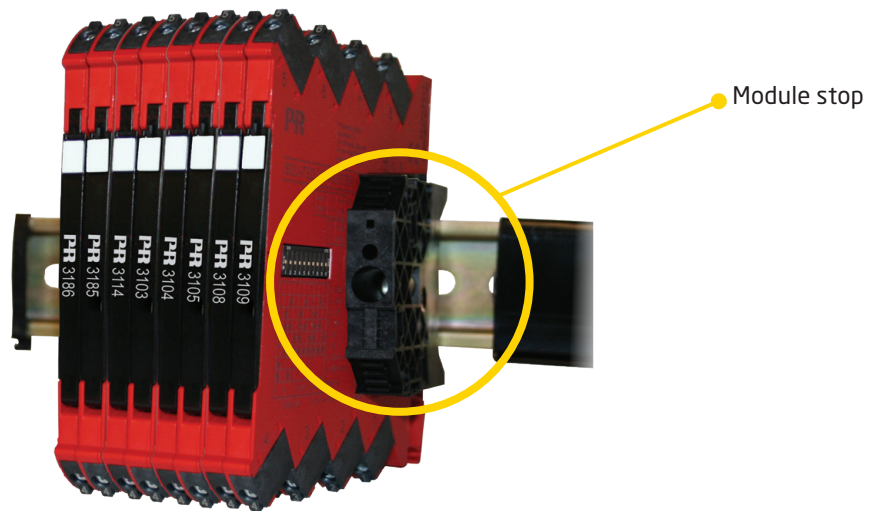

The 3118 can be installed on a DIN rail or on a power rail. For marine applications the devices must be supported by a module stop (PR part number 9404). Power supply units can be mounted on the power rail according to customer requirements.

If you want to install a 3118 device with power rail connectors on a standard DIN rail, the head of the screws holding the 7.5 mm DIN rail shall be no more than 3.5 mm high in order to avoid short circuit between the power rail connectors on the 3118 and the screws.

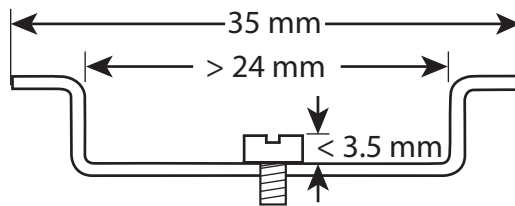

Supply of power rail

It is possible to supply the power rail via the supply terminals. The terminals can pass a current of max. 400 mA.

Marking

The front cover of the 3118 has been designed with an area for affixation of a click-on marker. The area assigned to the marker measures 5 x 7.5 mm. Markers from Weidmüller's MultiCard System, type MF 5/7.5, are suitable.

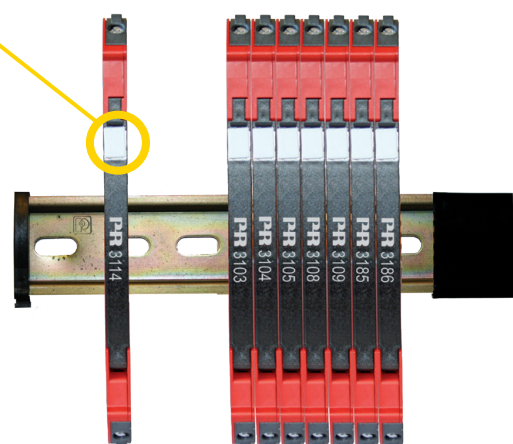

Side label

Terminal numbers

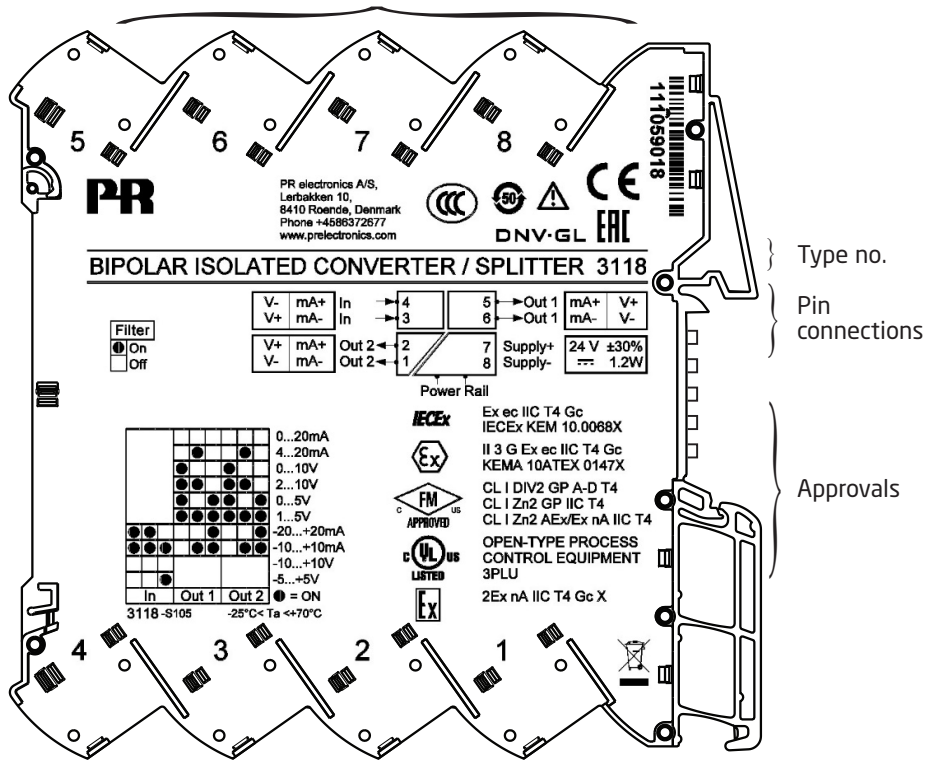

Bipolar isolated converter / splitter

3118

- Conversion of voltage and current bipolar process signals to uni-/bipolar signals
- Multiple signal ranges are selectable via DIP-switches
- Splitter function: 1 signal in and 2 signals out
- Excellent accuracy, better than 0.05 % of selected range and high output load stability

Applications

- The 3118 is an isolating converter and splitter which can be used for signal conversion of standard bipolar analog process signals into two individual unipolar analog signals.
- The unit offers 4-port isolation and provides surge suppression and protects control systems from transients and noise.
- The 3118 also eliminates ground loops and can be used for measuring floating signals.
- Mounting of the 3118 can be in Safe area or in Zone 2 and Cl. 1 Div 2 area and is approved for marine applications.
- The analog output can be easily configured and programmed to be bipolar in the ranges ± 10 mA and ± 20 mA (See "DIP-switch configuration" on page 16).

Technical characteristics

- Flexible 24 VDC ($\pm 30\%$) supply via power rail or connectors.
- Excellent conversion accuracy, better than 0.05% of selected range.
- A green front LED indicates operation status for the device.
- All terminals are protected against overvoltage and polarity error.
- Meeting the NAMUR NE21 recommendations, the 3118 ensures top measurement performance in harsh EMC environments.
- High galvanic isolation of 2.5 kVAC.
- Fast response time < 7 ms / > 100 Hz bandwidth – 10 Hz bandwidth damping possible via DIP-switch.
- Excellent signal/noise ratio > 60 dB.
- Wide ambient temperature range: $-25\dots+70^{\circ}\text{C}$.

Mounting / installation

- Fast and easy configuration of factory calibrated measurement ranges via DIP-switches.
- Units can be mounted side by side, horizontally and vertically, without air gap on a standard DIN rail, even at 70°C ambient temperature.
- The narrow 6.1 mm housing and very low power consumption allows up to 163 units per meter.

Order

| Type | Version |
|------|---|
| 3118 | With power rail connector / terminals : - |
| | Supplied via terminals : -N |

Example: 3118

Accessories

9404 = Module stop for rail

Accessories for power rail devices

3405 = Power rail connector unit

9400 = Power rail - 7.5 or 15 mm high

9410 = Power connector unit

9421 = Power supply

Technical data

Environmental conditions:

| | |
|---|----------------------|
| Operating temperature | -25°C to +70°C |
| Storage temperature | -40°C to +85°C |
| Calibration temperature | 20...28°C |
| Relative humidity | < 95% RH (non-cond.) |
| Protection degree | IP20 |
| Installation in pollution degree 2 & overvoltage category II. | |

Mechanical specifications:

| | |
|--------------------------------|--|
| Dimensions (HxWxD) | 113 x 6.1 x 115 mm |
| Weight approx. | 70 g |
| DIN rail type. | DIN EN 60715 - 35 mm |
| Wire size. | 0.13...2.5 mm ² / AWG 26...12 stranded wire |
| Screw terminal torque. | 0.5 Nm |
| Vibration. | IEC 60068-2-6 |
| 2...25 Hz. | ±1,6 mm |
| 25...100 Hz | ±4 g |

Common electrical specifications:

| | |
|---|--|
| Supply voltage, universal. | 16.8...31.2 VDC |
| Max. required power | 1.20 W |
| Max. power dissipation | 0.43 W |
| <i>Max. required power is the maximum power needed at power supply terminals or rail connector.</i> | |
| <i>Max. power dissipation is the maximum power dissipated at nominal operating values.</i> | |
| Isolation voltage, test | 2.5 kVAC |
| Isolation voltage working. | 300 VAC (reinforced) / 250 VAC (Zone 2, Div. 2) |
| MTBF, acc. to IEC 61709 (SN29500) | > 187 years |
| Signal dynamics, input / output | Analog signal chain |
| Signal / noise ratio | Min. 60 dB (0...100 kHz) |
| Cut-off frequency (3 dB) | > 100 Hz or 10 Hz (selectable via DIP-switch) |
| Response time (0...90%, 100...10%) | < 7 ms or < 44 ms |

Input specifications:**Current input:**

Measurement range -23...+23 mA
 Programmable measurement ranges ±10 and ±20 mA
 Input voltage drop < 1 VDC @ 23 mA

Voltage input:

Measurement range -11.5 ... +11.5 V
 Programmable measurement ranges ±5 and ±10 V
 Input resistance ≥ 1 MΩ

Output specifications:**Current output:**

Signal range (span) 0...23 mA
 Programmable signal ranges 0...20 and 4...20 mA
 (*) Bipolar wiring and programming set-up ±10 and ±20 mA
 Load ≤ 300 Ω per channel
 Load stability ≤ 0.02% of span / 100 Ω
 Current limit. ≤ 28 mA

Voltage output:

Signal range. 0...10 VDC
 Programmable signal ranges 0...5, 1...5, 0...10, 2...10 V
 Load (min.) >10 kΩ

of span = of the selected range

| Accuracy values | | |
|---|-------------------|-------------------------|
| Input type | Absolute accuracy | Temperature coefficient |
| All | ≤ ±0.05% of span | ≤ ±0.01% of span / °C |
| EMC - immunity influence. < ±0.5% of span | | |
| Extended EMC immunity: NAMUR NE 21, A criterion, burst < ±1% of span | | |

Observed authority requirements:

EMC. 2014/30/EU
 LVD 2014/35/EU
 ATEX 2014/34/EU
 RoHS 2011/65/EU
 EAC TR-CU 020/2011
 EAC Ex TR-CU 012/2011

Approvals:

DNV, Ships & Offshore. TAA00001Rw
 c UL us, UL 61010-1. E314307

I.S. / Ex approvals:

ATEX KEMA 10ATEX0147 X
 IECEx. KEM 10.0068 X
 c FM us. FM17US0004X / FM17CA0003X
 CCC 2020322310003554
 EAC Ex RU C-DK.HA65.B.00355/19

Connections

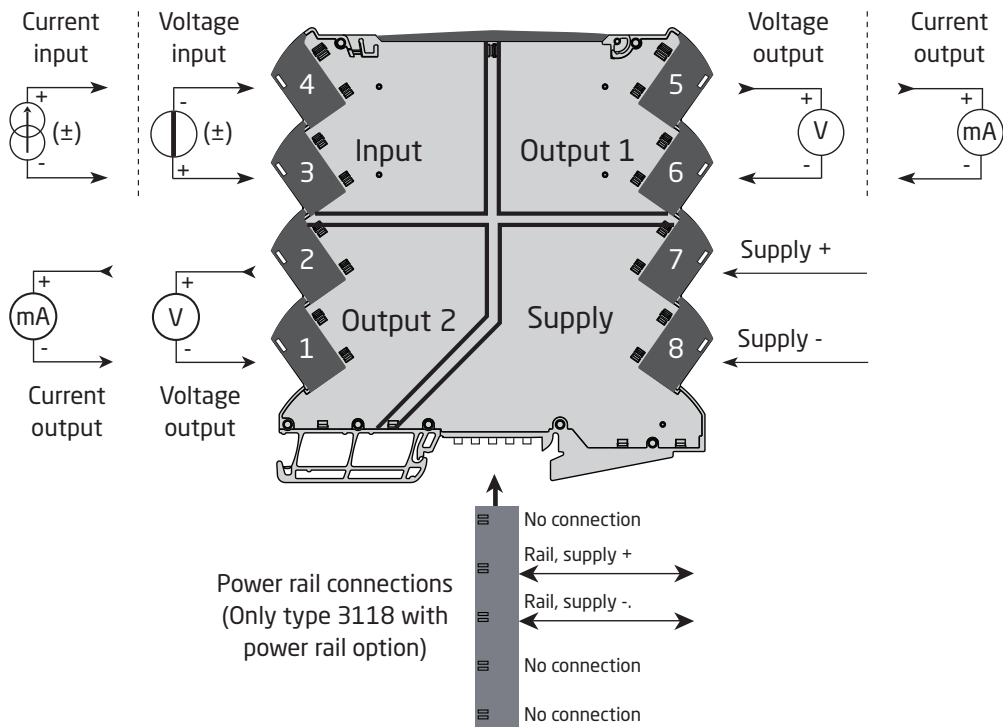

(*) Bipolar Input to bipolar output wiring set-up:

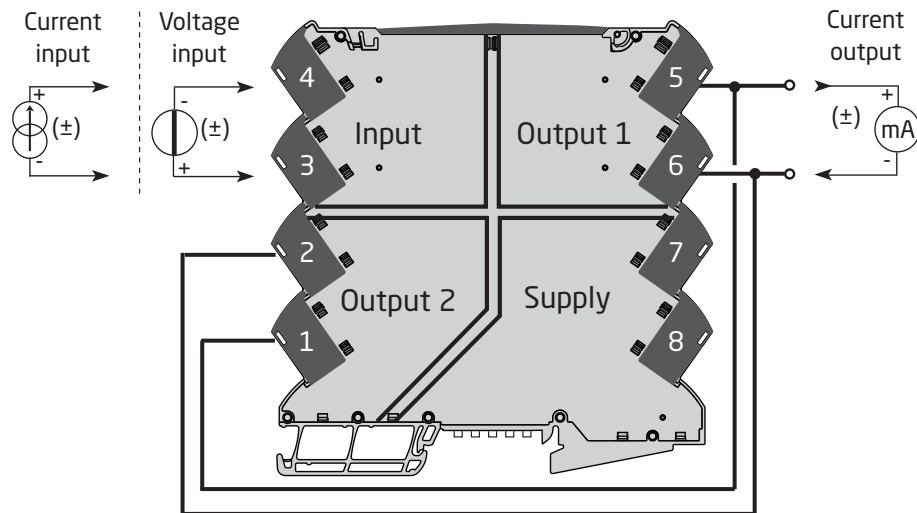

**Safe Area or
Zone 2 & Cl. 1, Div. 2, gr. A-D**

LED indication

The device is equipped with a green power LED in the front to indicate the operation status, see the table below.

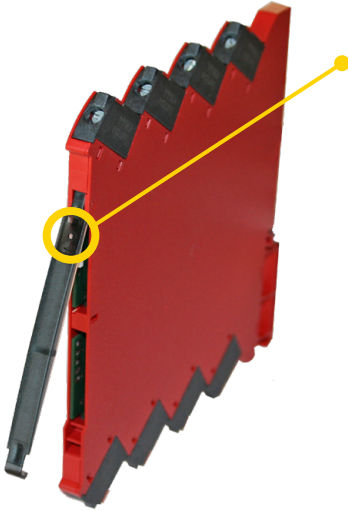

| Condition | LED | Outputs | Action required |
|------------------------------|-----------------------------------|--------------|-------------------------------------|
| No supply / device error | OFF | De-energized | Connect supply / replace device |
| Power-up or restart | 1 Flash (0.5 s OFF + 0.5 s ON) | De-energized | - |
| Device OK | Flashing 13 Hz (15 ms ON) | Energized | - |
| Incorrect DIP-switch setting | Flashing 1 Hz (15 ms ON) | De-energized | Correct setting and re-power device |
| Supply or hardware error | Flashing 13 Hz (0.5 s ON) | De-energized | Check supply/ replace device |

DIP-switch configuration

3118 can be configured via DIP-switches. The DIP-switches are located on the side of the device and can be adjusted with a small screwdriver or other implement.

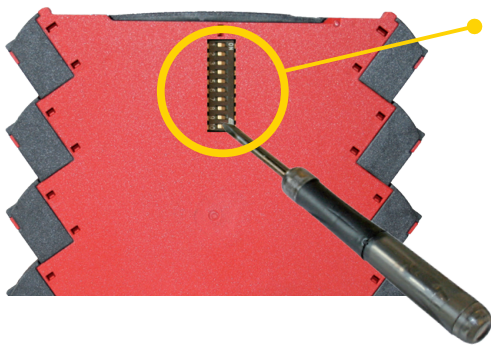

Adjustment of DIP-switches.

Default factory settings are:

Input = -10...+10 V

Output = 0...20 mA

All DIP-switches in the OFF position

| | | |
|--|--|--|
| DIP-switch positions are only read at power up. (*) = bipolar wiring set-up | Output ch. 1 Current 0...20 mA | Output ch. 2 Current 0...20 mA |
| | Output ch. 1 Current 4...20 mA | Output ch. 2 Current 4...20 mA |
| Filter ON Bandwidth 10 Hz | Output ch. 1 Current ± 20 mA set-up* | Output ch. 2 Current ± 20 mA set-up* |
| Filter OFF Bandwidth > 100 Hz | Output ch. 1 Current ± 10 mA set-up* | Output ch. 2 Current ± 10 mA set-up* |
| Input Current -10...+10 mA | Output ch. 1 Voltage 0...10 V | Output ch. 2 Voltage 0...10 V |
| Input Current -20...+20 mA | Output ch. 1 Voltage 2...10 V | Output ch. 2 Voltage 2...10 V |
| Input Voltage -5...+5 V | Output ch. 1 Voltage 0...5 V | Output ch. 2 Voltage 0...5 V |
| Input Voltage -10...+10 V | Output ch. 1 Voltage 1...5 V | Output ch. 2 Voltage 1...5 V |

Document history

The following list provides notes concerning revisions of this document.

| Rev. ID | Date | Notes |
|----------------|-------------|--|
| 101 | 1803 | Model 3118-N added. Specifications for max. required power and power dissipation added. PESO/CCOE approval added. |
| 102 | 2108 | PESO/CCOE approval discontinued. CCC approval added. ATEX and IECEx approvals updated - Ex na changed to Ex ec. Side label updated. |

We are near you, *all over the world*

Our trusted red boxes are supported wherever you are

All our devices are backed by expert service and a 5-year warranty. With each product you purchase, you receive personal technical support and guidance, day-to-day delivery, repair without charge within the warranty period and easily accessible documentation.

We are headquartered in Denmark, and have offices and authorized partners the world over. We are a local

business with a global reach. This means that we are always nearby and know your local markets well. We are committed to your satisfaction and provide **PERFORMANCE MADE SMARTER** all around the world.

For more information on our warranty program, or to meet with a sales representative in your region, visit prelectronics.com.

Benefit today from *PERFORMANCE MADE SMARTER*

PR electronics is the leading technology company specialized in making industrial process control safer, more reliable and more efficient. Since 1974, we have been dedicated to perfecting our core competence of innovating high precision technology with low power consumption. This dedication continues to set new standards for products communicating, monitoring and connecting our customers' process measurement points to their process control systems.

Our innovative, patented technologies are derived from our extensive R&D facilities and from having a great understanding of our customers' needs and processes. We are guided by principles of simplicity, focus, courage and excellence, enabling some of the world's greatest companies to achieve PERFORMANCE MADE SMARTER.