

Robust and precise.

Noncontact, wear-free and contamination-resistant—maximum accuracy with patented technology.

PMI Inductive Positioning Systems



Your automation, our passion.

 **PEPPERL+FUCHS**

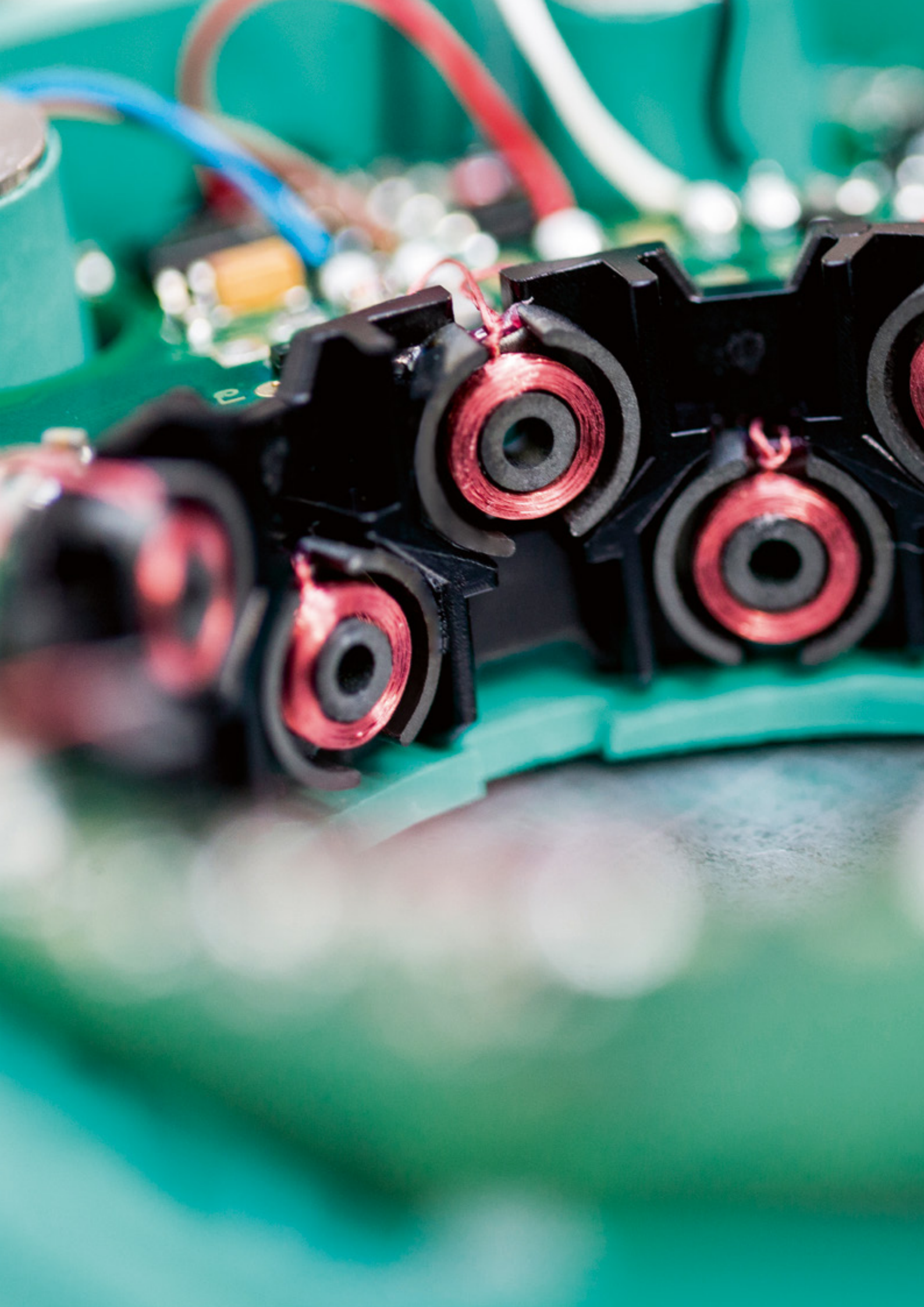

Technology

From Proximity Sensor to Positioning System

As the inventor of the proximity sensor, Pepperl+Fuchs has continuously developed and perfected this noncontact, wear-free technology. With the highest quality standards and the most experience on the market, we offer a well-rounded portfolio of inductive positioning systems.

Precise Positioning on Steel

PMI inductive positioning technology combines the ruggedness of an inductive proximity sensor with the precision of a position measurement and angular positioning system. The patented technology ensures highly accurate measurements. The use of simple steel actuators is designed to maximize the flexibility of your application.

Commitment to Quality

Reliability, machine availability, and the highest quality standards are the principles behind Pepperl+Fuchs' proximity sensors. As a pioneer in sensor technology, our top priority is offering customers high-quality products and reliable solutions for the future. Using test criteria far beyond the requirements, Pepperl+Fuchs sets standards for performance and durability.

Key Benefits

- Maximum durability with noncontact, maintenance-free technology and high environmental protection
- Simple steel actuator opens up a variety of possible applications
- Flexibility due to a wide range of functions and programmable measuring and switching range
- A variety of housing styles: from compact designs for machine tools (14 mm measurement length) to designs for heavy machinery (960 mm measurement length)
- High noise immunity ensures process reliability
- Increased efficiency with measuring and switching functions in one device

Patented Technology for Precise Position Detection

The PMI inductive positioning system is used to detect linear position and measure rotation angle. It is reliable even in dusty and dirty environments and under extreme temperature fluctuations.

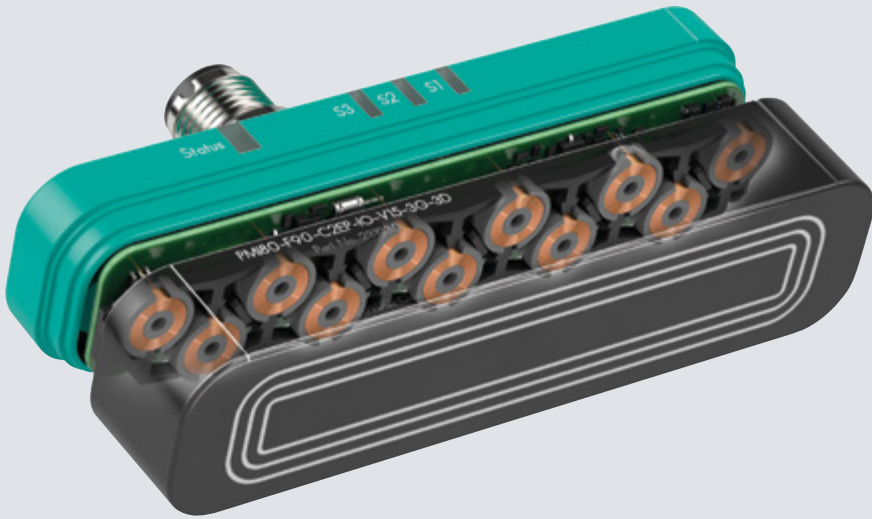

Maximum Precision and Efficiency

A patented configuration and wiring of multiple coils within a single sensor and intelligent evaluation enable maximum precision and efficiency. This allows simple steel actuators to be used. Whether the actuator is the customer's design, from Pepperl+Fuchs's accessory portfolio, or part of the machine module being monitored—PMI inductive positioning systems always detect the exact position.

Measuring and Switching with One Sensor

Depending on the application requirements, both the measuring range and several switch points or windows can be defined in one sensor. This allows PMI sensors to function simultaneously as position sensors and limit switches. Only a single device is needed where other solutions require multiple sensors.

Sensorik4.0®—Paving the Way for the Smart Factory

Equipped with IO-Link, PMI inductive positioning systems pave the way for the fourth industrial revolution. In the Industry 4.0 future of fully networked production systems, communication-ready sensors play a vital role: they send and receive sensor data within production processes and to higher-level local or cloud-based information systems.

To pave the way for Industry 4.0, Pepperl+Fuchs is providing innovative sensor technologies with Sensorik4.0®. They use the standard IO-Link interface to support the digitization of industrial applications.

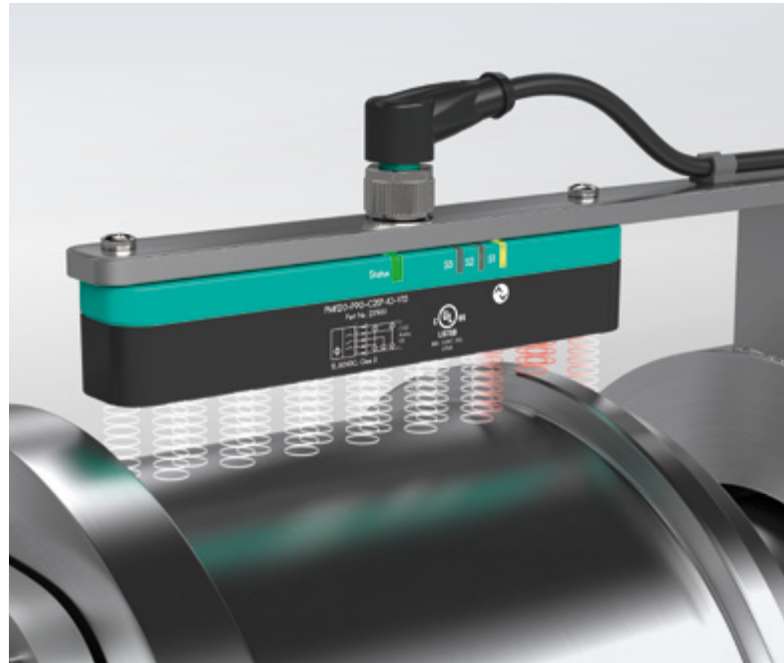

Find the Right Positioning System in Just a Few Clicks

Go online. Specify the requirements. Select your sensor. You will find the right solution for your application in just a few clicks. If you have any questions, our experts will be happy to take your call.

Enter the series name in the search box on the Pepperl+Fuchs website and you will be taken to your product selection. The series name can be found in the technical data excerpt in this brochure. Or you can navigate through our various product families and groups. Product selectors help you select the optimal positioning system.

For example:
"PMI*F90-IU-IO"



For more information, visit
[pepperl-fuchs.com/pmi](https://www.pepperl-fuchs.com/pmi)

Maximum Performance and Flexibility



F90 Series

IO-Link, simultaneous detection of two damping elements, as well as measuring and switching functions in one device—the F90 series offers an unprecedented range of features for your application. Available in three measurement lengths (40 mm, 80 mm, and 120 mm), the best solution is always available.

Certified versions are also available for applications in ATEX Zone 2/22 (3G ec, 3D tc) hazardous locations.

Highlights

- New applications made possible by IO-Link
- Distance measurement between two targets to solve complex applications with just one sensor
- Measuring and switching in one device
- Certified versions for use in ATEX Zone 2/22 (3G ec, 3D tc) hazardous locations

Technical Data	PMI*F90-IU-IO	PMI*F90-3EP-IO	PMI*F90-IU2EP-IO	PMI*F90-IU2EP-IO*3G-3D
Measurement length	40, 80, 120 mm	40, 80, 120 mm	40, 80, 120 mm	40, 80, 120 mm
Output type	1 analog output (current or voltage)	3 switching outputs (push-pull)	1 analog output 2 switching outputs (push-pull)	1 analog output 2 switching outputs (push-pull)

Zone 2/22 (3G ec, 3D tc)

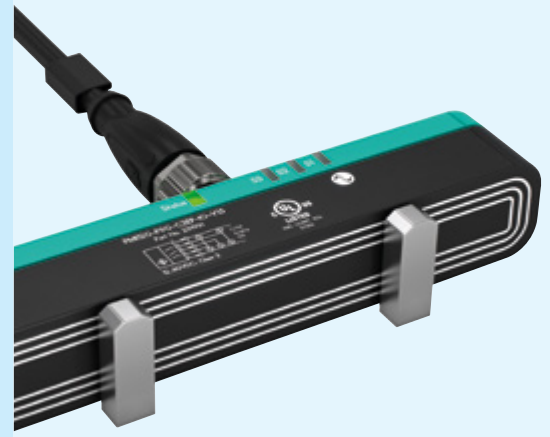
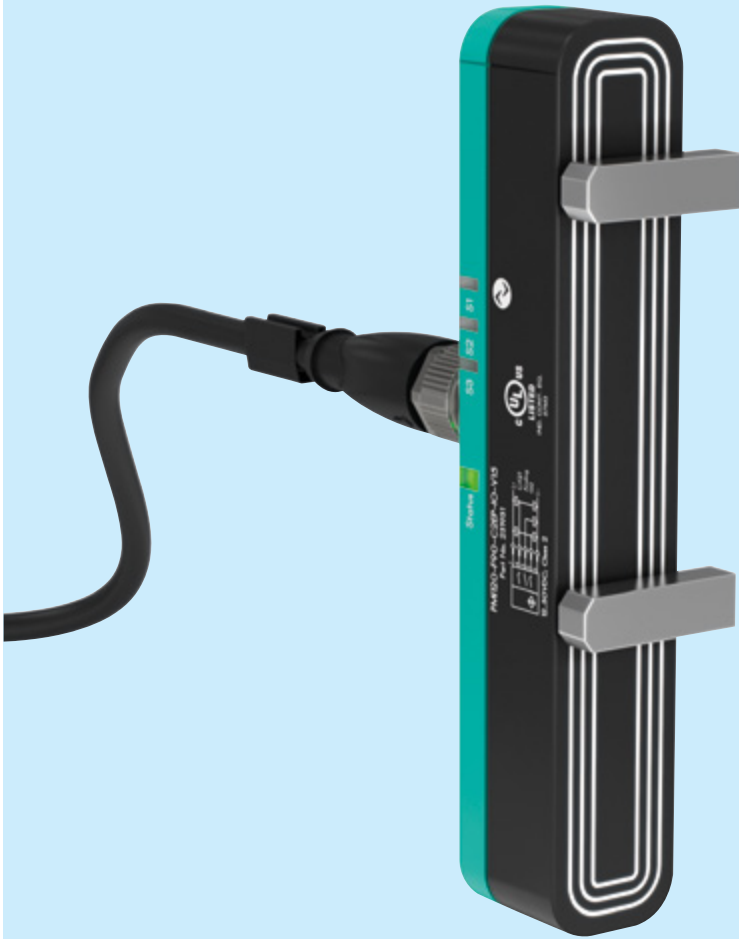

New Possibilities with IO-Link

Communication down to the sensor/actuator level, customer-specific parameterization, and access to valuable additional information: The IO-Link interface opens up completely new possibilities in position detection. In addition to process data, value-added data such as the signal quality or number of operating hours can be accessed directly from the sensor.

With accurate event logs, you can determine how frequently the target leaves the measuring range and draw direct conclusions about mechanical tolerances, wear, or setting errors. This enables event-oriented maintenance—fully in line with Industry 4.0.

Simultaneous Detection of Two Targets

With the ability to detect two damping elements at the same time, the F90 can handle applications that normally require two separate devices. The proximity of the damping elements to one another is output directly as an analog value and can be used by the machine control without additional calculation. A second sensor is not required, increasing efficiency during mounting and integration.



IO-Link



Measuring and switching in one device



Zone 2/22 (3G ec, 3D tc)



Degree of protection

Reliable Processes, Countless Applications

Controlling dancer systems in packaging machines, monitoring clamping cylinders, or providing valve position feedback in hazardous locations—the versatile F90 series can be used in a wide variety of applications.

Efficient Dancer Control

In winding and unwinding processes in the packaging industry, tearing or sagging of the paper or film must be prevented. The guide roller, known as the “dancer,” continuously adapts to the speed of the machine to ensure reliable material feed.

The F90 series reliably detects the position of the dancer and allows it to be controlled precisely. By combining measuring and switching functionality in one device, it also allows two switch points or windows to be defined. This will give you not only the position of the dancer as an analog value but also the two limit switch positions as a switching signal from a single device. The dancer can be controlled highly efficiently without needing additional sensors.



Safe Use in Hazardous Areas

Quick and easy to mount on pneumatic diaphragm valves or linear control valves, the F90 series delivers continuous position feedback and provides an ideal solution for precise valve position detection. Certified versions allow the system to be used in ATEX Zone 2/22 (3G nA, 3D tc) hazardous locations.

IP67 protection and a temperature rating of -25°C to $+85^{\circ}\text{C}$ ensure reliable positioning in outdoor environments.

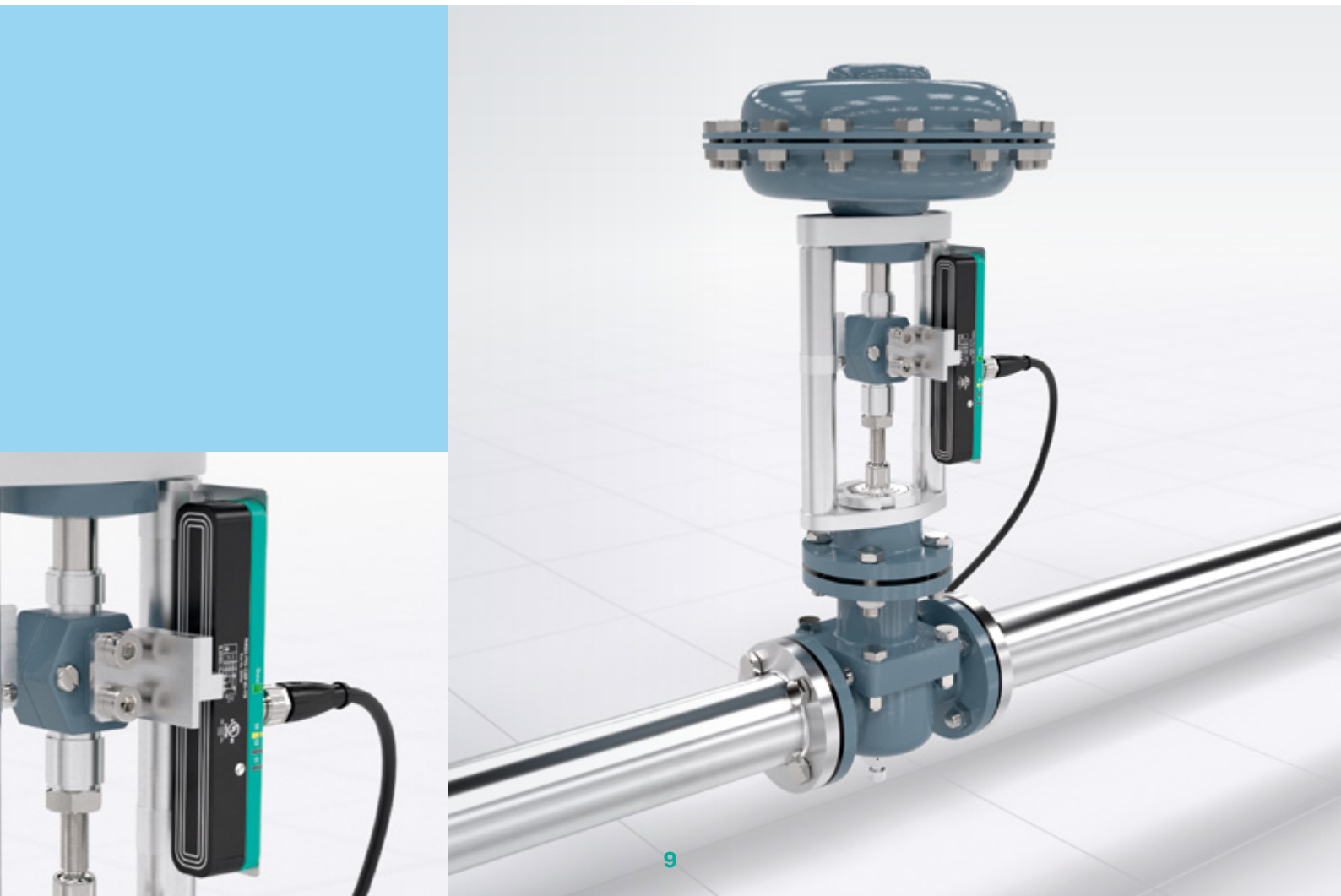

Communication-Ready Even in Compact Spaces

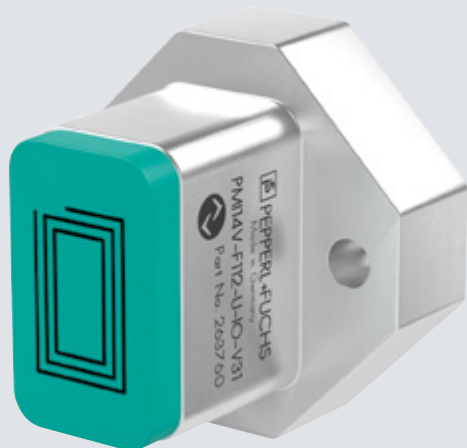

F112 Series

With a measurement length of 14 mm, the F112 series provides high-precision position data or switch points/windows. Fully encapsulated in a rugged metal housing with IP67 protection, the sensor withstands tough conditions and, with IO-Link, offers new possibilities in space-restricted applications.

Highlights

- New possibilities with IO-Link—even in space-restricted applications
- Compact, rugged metal housing for use in extreme conditions
- Flexible application by adjusting the detection range and parameterizing switch points and windows

Technical Data	PMI*F112-U-V3	PMI*F112-U-IO	PMI*F112-2EP-IO	PMI*F112-2EPE2-IO
Measurement length	14 mm	14 mm	14 mm	14 mm
Output type	1 analog output (voltage)	1 analog output (voltage)	2 switching outputs (push-pull)	2 switching outputs (push-pull) 1 switching output (PNP)

Base version without IO-Link

Individual Parameterization with IO-Link

Despite its compact design, an IO-Link interface is integrated into the F112 series. Individual parameterization options allow you to set the detection range and switch points/windows. This way, you can adapt the sensor to the circumstances at hand and optimize your application.

In addition to transmitting process data, the IO-Link interface also allows direct access to value-added data, such as error messages.



IO-Link



Degree of protection

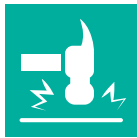

Metal housing

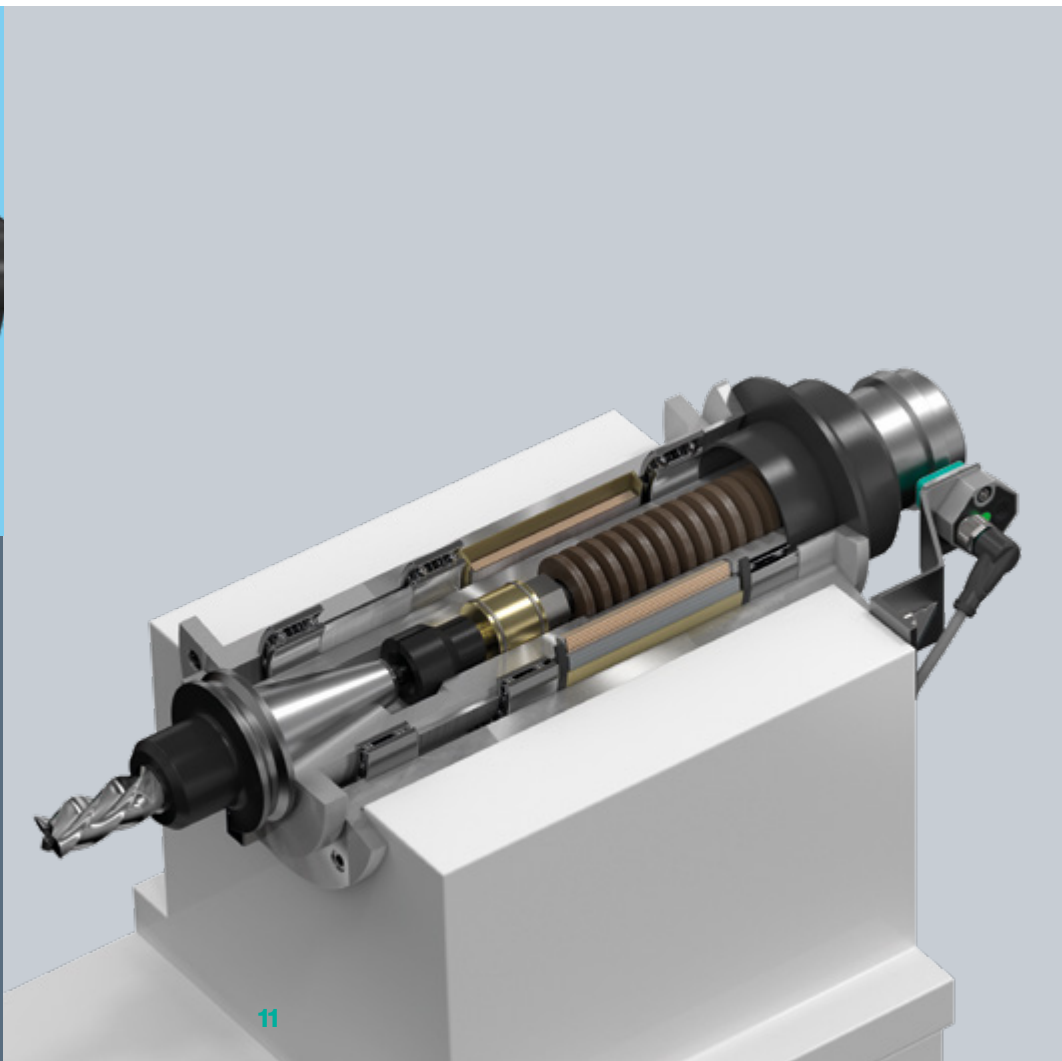

Low-Profile and Rugged for Small Spaces

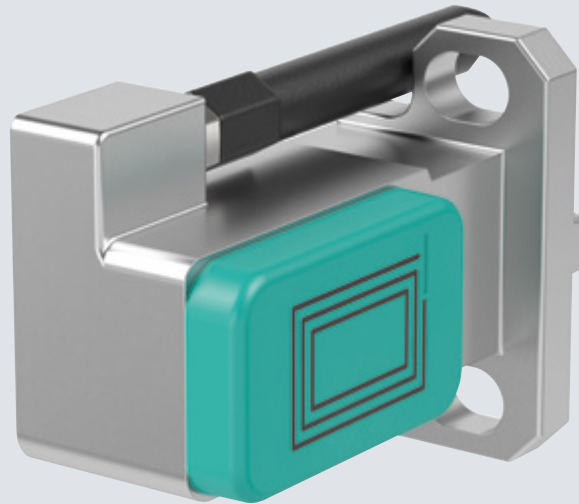

F166 Series

Its compact design, rugged metal housing and IO-Link interface make the F166 series perfect for basic applications in tight spaces.

Tool spindles are a typical application where these benefits are put to use. The compact design makes it easy to integrate the sensor into the spindle, and the rugged metal housing resists lubricants and abrasion to ensure smooth operation.

Highlights

- Low-profile design for installation in tight spaces
- Rugged metal housing withstands extreme conditions
- Application flexibility due to switching output, analog output or IO-Link interface

Technical Data	PMI*F166-U	PMI*F166-2E2	PMI*F166-EP-IO
Measurement length	14 mm	14 mm	15 mm
Output type	1 analog output (voltage)	2 switching outputs (PNP)	1 switching output (push-pull) IO-Link



IO-Link



Metal housing

F110 Series

High Reliability and Accuracy for Long Measurement Lengths

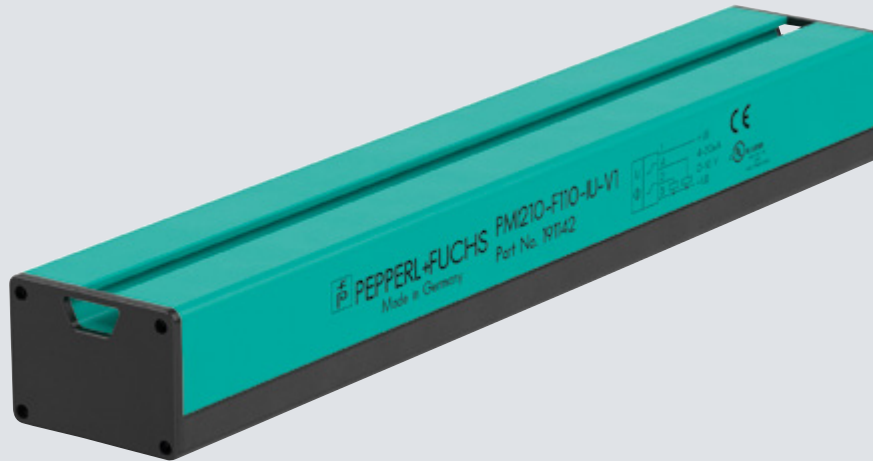

F110 Series

The F110 series offers reliable position detection over long measurement lengths. Available in several lengths between 210 mm and 960 mm, the F110 series provides an optimal solution for applications in heavy machinery construction. Its sensing range of up to 6 mm can handle large mechanical tolerances without affecting the precision of the measurement

Installation is also simple; the mounting position can be set and adjusted via T-slot nuts.

Highlights

- Reliable inductive position detection at measurement lengths of up to 960 mm
- Exact positioning even with larger mechanical tolerances
- Simple and flexible mounting via T-slot nuts
- Rugged metal housing for use in demanding conditions

Technical Data

PMI*F110-IU

Measurement length

210, 360, 510, 810, 960 mm

Output type

1 analog output (voltage)



Metal housing

Wear-Free Angle Detection



F130 Series

Unlike PMIs that measure linearly, F130 series sensors convert a measurement angle from 0° to 360° into an analog signal between 4 mA and 20 mA. This makes it perfect for valve position detection on valve actuators, among other applications.

The sensor can be operated in either a clockwise or counter-clockwise direction with a steel actuator provided by the customer or selected from Pepperl+Fuchs' portfolio. The scalable measuring range and adjustable switch points/windows complete this special design and make the F130 series the perfect solution for angle detection.

Highlights

- Noncontact, wear-free angle measuring system with a measuring range from 0° to 360°
- Efficient angle position feedback due to optimized product models and standardized drilling template for position feedback sensors
- Rugged, fully encapsulated sensors rated up to IP67 for outdoor applications

Technical Data	PMI*F130-IU-V15	PMI*F130-IU2E2	PMI*F130-IE8	PMI*F130-3E2	PMI*F130-I2E2
Measurement range	0–360° (scalable)	0–360° (scalable)	0–360° (scalable)	0–360° (scalable)	Min: 0–90° Max: 0–180° (scalable)
Output type	1 analog output (current or voltage)	1 analog output (current or voltage) 2 switching outputs (PNP)	1 analog output (current) 2 switching outputs (PNP)	3 switching outputs (PNP)	1 analog output (current) 2 switching outputs (PNP)

Efficient Rotation Angle Detection on Valve Actuators

The standardized drilling template for position feedback sensors in the process industry enables direct mounting on all standard pneumatic drives. In addition to analog angle position feedback, the sensor also provides two programmable switch windows for end position monitoring.

A preconfigured model (PMI90-F130-I2E2) is available for use as a position feedback sensor in the process industry. All pre-parameterized settings, such as the direction of rotation, the swivel angle, as well as the switch window position and width can be adjusted as needed.

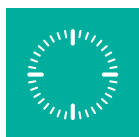

Measurement range 0 ... 360°



Measuring and switching in one device



Degree of protection

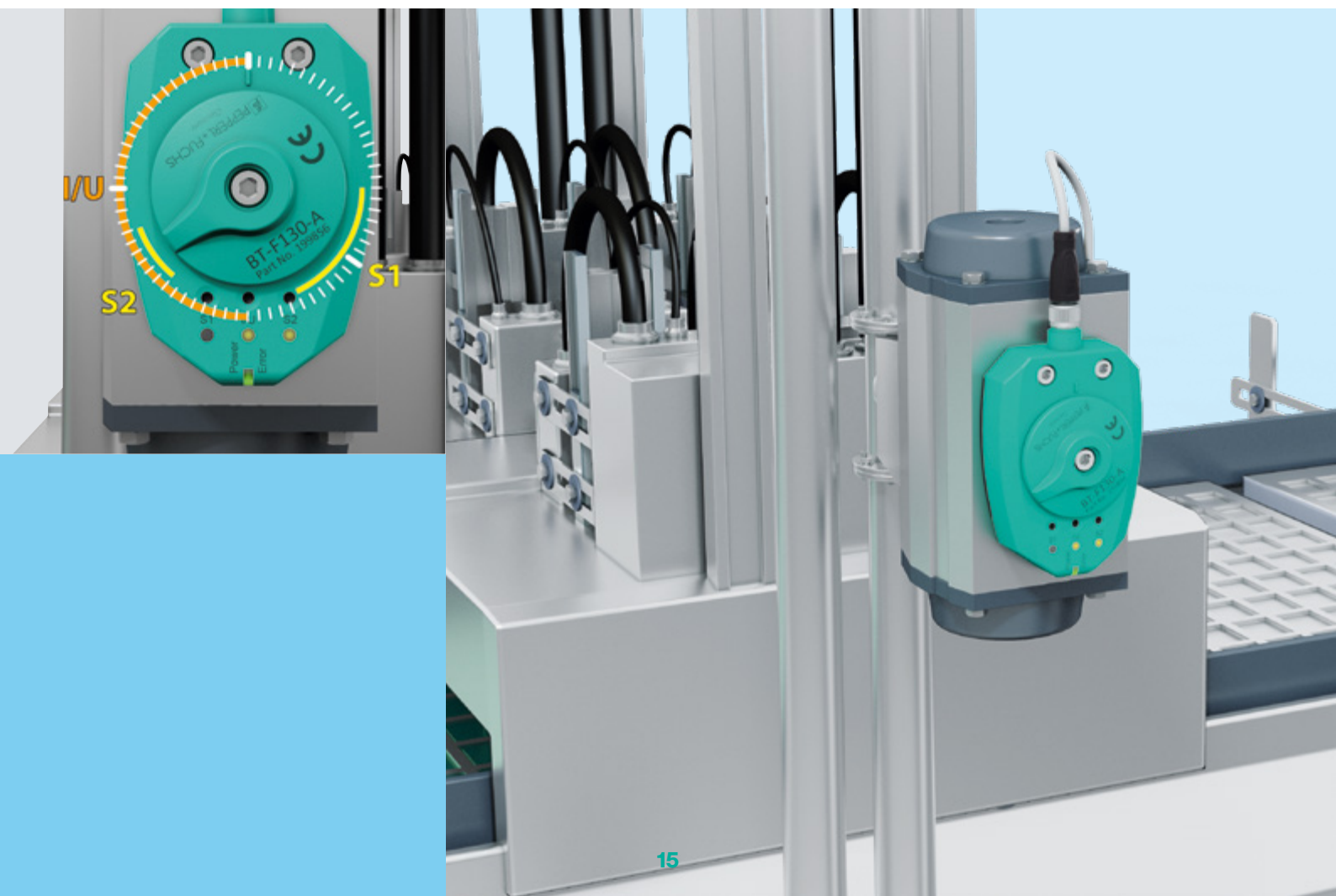

Your automation, our passion.

Explosion Protection

- Intrinsic Safety Barriers
- Signal Conditioners
- FieldConnex® Fieldbus
- Remote I/O Systems
- Electrical Explosion
- Purge and Pressurization Systems
- Industrial HMI
- Mobile Computing and Communications
- HART Interface Solutions
- Surge Protection
- Wireless Solutions
- Level Measurement

Industrial Sensors

- Proximity Sensors
- Photoelectric Sensors
- Industrial Vision
- Ultrasonic Sensors
- Rotary Encoders
- Positioning Systems
- Inclination and Acceleration Sensors
- Fieldbus Modules
- AS-Interface
- Identification Systems
- Displays and Signal Processing
- Connectivity

www.pepperl-fuchs.com

Subject to modifications • © Pepperl+Fuchs
Printed in Germany • Part. No. 185116 09/21 08 • public



Pepperl+Fuchs Quality

Download our latest policy here:

www.pepperl-fuchs.com/quality