

Overview

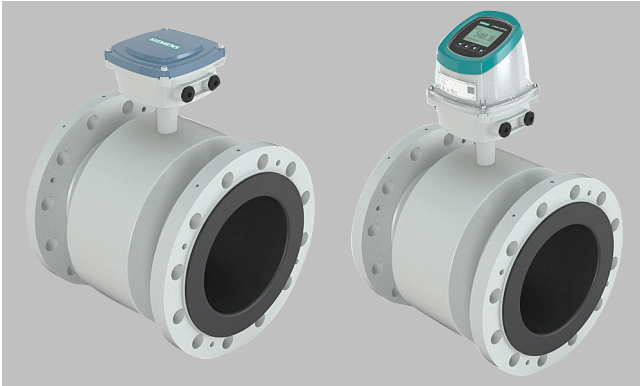

The SITRANS FMS300 is a magnetic flow sensor suitable for volume flow measurement of liquids (conductive) providing a high flexibility in the product configuration making the meter work in almost any flow applications.

The FMS300 is deliverable in a wide range of sizes, grounding electrodes are included as standard, measuring electrodes capable of withstanding the most extreme processes and various liners are also available. The fully welded construction provides supreme ruggedness and durability even under the toughest operating conditions.

Combined with a flow meter transmitter it is a traditional externally powered electromagnetic flow meter system.

Benefits

- Wide range of electrode and liner materials to fit even the most extreme process media
- Excellent chemical resistance also during high process temperature
- Reinforced PFA liner to perform extremely well under vacuum conditions and during high process temperatures up to 100 °C (212 °F)
- Fully welded construction with no moving parts for maintenance-free operation over many years
- Smooth surface with minimal risk of build-up
- Sensor face-to-face length according to ISO 20456 (up to DN 400 mm)
- SENSORPROM™ Technology provides an automatic upload of start-up settings and calibration data for easy commissioning
- Designed to allow in-situ verification for easy performance check
- Meets EEC directive PED 2014/68/EU

Application

The SITRANS FMS300 is designed to meet the most common specifications within the chemical and process industries. The field proven flow sensor with high chemical resistance is also the ideal solution for the tough and challenging applications.

The main applications of the SITRANS FMS300 flow sensor can be found in the following fields:

- Process industry
- Chemical industry
- Steel industry
- Mining
- Pulp and paper
- Utility
- Power generation and distribution
- Oil and gas / HPI
- Water and wastewater

For a complete magnetic flowmeter, the FMS300 flow sensor can be combined with a FMT020 transmitter. The entire flowmeter system either mounted remotely or as a compact unit is operated under the product name SITRANS FM320.

SITRANS FM320: This versatile magnetic flowmeter finds its primary applications in the chemical industry, process industry, pulp and paper sector, and industrial wastewater management.

Available sensor sizes from DN 15 to DN 2200 (1/2" ... 88")

Measuring accuracy $\pm 0.4\%$ of flow rate, optional $\pm 0.2\%$ of flow rate available.

SITRANS FM (electromagnetic)

Flow sensors

SITRANS FMS300

Selection and ordering data

Sensor SITRANS FMS300	Article No. 7ME636											
	●	-	●	●	●	●	●	-	●	●	A	●
Click on the Article No. for the online configuration in the PIA Life Cycle Portal.												
Transmitter variant												
No transmitter (sensor only)											0	
Transmitter SITRANS FMT020											2	
Diameter												
DN 15, ½ inch											1	V
DN 25, 1 inch											2	D
DN 32, 1¼ inch											2	H
DN 40, 1½ inch											2	R
DN 50, 2 inch											2	Y
DN 65, 2½ inch											3	F
DN 80, 3 inch											3	M
DN 100, 4 inch											3	T
DN 125, 5 inch											4	B
DN 150, 6 inch											4	H
DN 200, 8 inch											4	P
DN 250, 10 inch											4	V
DN 300, 12 inch											5	B
DN 350, 14 inch											5	D
DN 400, 16 inch											5	H
DN 450, 18 inch											5	K
DN 500, 20 inch											5	R
DN 600, 24 inch											5	Y
DN 700, 28 inch											6	B
DN 750, 30 inch											6	D
DN 800, 32 inch											6	H
DN 900, 36 inch											6	K
DN 1000, 40 inch											6	R
DN 1050, 42 inch											6	Y
DN 1100, 44 inch											7	D
DN 1200, 48 inch											7	H
DN 1400, 54 inch											7	M
DN 1500, 60 inch											7	R
DN 1600, 66 inch											7	V
DN 1800, 72 inch											7	Y
DN 2000, 80 inch											8	B
DN 2200, 88 inch											8	F
Process connection												
EN 1092-1 PN 6 flanges												A
EN 1092-1 PN 10 flanges												B
EN 1092-1 PN 16 flanges, standard face-to-face length for sensor (1.3 × DN, DN 700 ... 1200)												C
EN 1092-1 PN 16 flanges, short face-to-face length for sensor (1.0 × DN) (not concerned by PED)												D
EN 1092-1 PN 25 flanges												E
EN 1092-1 PN 40 flanges												F
EN 1092-1 PN 63 flanges												G
EN 1092-1 PN 100 flanges												H
ANSI B16.5 Class 150 flanges												J
ANSI B16.5 Class 300 flanges												K
ANSI B16.5 Class 600 flanges												L
AWWA C-207 Class D flanges												M
AS 2129 table E flanges												Q
AS 4087 PN 16 flanges												S
AS 4087 PN 21 flanges												T
AS 4087 PN 35 flanges												U
JIS B 2220:2004 10K flanges												W
JIS B 2220:2004 20K flanges												Y

Selection and ordering data (continued)

Sensor SITRANS FMS300	Article No. 7ME636	●	-	●	●	●	●	●	-	●	●	A	●
Process connection material													
Carbon steel ASTM A 105 with corrosion-resistant coating acc. to EN ISO 12944 class C4													0
Carbon steel ASTM A 105 with corrosion-resistant coating acc. to EN ISO 12944 class C5													1
Stainless steel AISI 304 flange with corrosion-resistant coating acc. to EN ISO 12944 class C4													3
Stainless steel AISI 304 flange with corrosion-resistant coating acc. to EN ISO 12944 class C5													4
Stainless steel AISI 316L flange (including sensor housing), polished													8
Liner material													
Soft rubber (Neoprene)													1
EPDM													2
PTFE													3
Ebonite													4
Linatex													5
PFA													7
Electrode material													
Stainless steel AISI 316Ti / 1.4571													0
Hastelloy C276 / 2.4819 (PFA: Hastelloy C22 / 2.4602)													1
Platinum													2
Titanium													3
Tantalum													4
Ceramic coated stainless steel AISI 316Ti / 1.4571													5
Ceramic coated Hastelloy C276 / 2.4819													6
Transmitter mounting & enclosure type													
No transmitter (sensor only)													A
Compact design (integral mount), polycarbonate enclosure													G
Remote design, polycarbonate enclosure (wall-mounting unit and sensor terminal board included)													J
Power supply													
No transmitter (sensor only)													0
12 ... 42 V DC													2
100 ... 240 V AC, 50/60 Hz													3

Selection and Ordering data	Order code
Additional information	
Please add "-Z" to Article No. and specify Order code(s) and plain text.	
Cable glands	
Without cable glands (blind plugs)	A00
M20x1.5 cable glands, material polyamide	A02
½ inch NPT cable glands, material polyamide	A05
Certificates	
Declaration of compliance with the order 2.1 (EN 10204)	C00
Inspection certificate 3.1 (EN 10204) - Material of pressure-containing and wetted parts	C12
Test report 2.2 (EN 10204)	C14
Inspection certificate 3.1(EN 10204) - Pressure test	C18
High accuracy calibration	
High accuracy factory calibration 0.2%, DN ≤ 200, ≤ 8 inch	D01
High accuracy factory calibration 0.2%, DN 250 ... 600, 10 ... 24 inch	D02
High accuracy factory calibration 0.2%, DN 700 ... 1200, 28 ... 48 inch	D03
5-point calibration	
5-point factory calibration, DN ≤200, ≤ 8 inch	D10
5-point factory calibration, DN 250 ... 600, 10 ... 24 inch	D11
5-point factory calibration, DN 700 ... 1200, 28 ... 48 inch	D12
10-point calibration	
10-point factory calibration, DN ≤200, ≤ 8 inch	D15
10-point factory calibration, DN 250 ... 600, 10 ... 24 inch	D16
10-point factory calibration, DN 700 ... 1200, 28 ... 48 inch	D17

Selection and Ordering data	Order code
Additional information	
Default matched-pair calibration	
Default matched-pair factory calibration, DN ≤200, ≤ 8 inch	D20
Default matched-pair factory calibration, DN 250 ... 600, 10 ... 24 inch	D21
Default matched-pair factory calibration, DN 700 ... 1200, 28 ... 48 inch	D22
5-point matched-pair calibration	
5-point, matched-pair factory calibration, DN ≤200, ≤ 8 inch	D25
5-point, matched-pair factory calibration, DN 250 ... 600, 10 ... 24 inch	D26
5-point, matched-pair factory calibration, DN 700 ... 1200, 28 ... 48 inch	D27
10-point matched-pair calibration	
10-point, matched-pair factory calibration, DN ≤200, ≤ 8 inch	D30
10-point, matched-pair factory calibration, DN 250 ... 600, 10 ... 24 inch	D31
10-point, matched-pair factory calibration, DN 700 ... 1200, 28 ... 48 inch	D32
Accredited ISO/IEC 17025 calibration	
ISO/IEC 17025 accredited, 5-point, matched-pair factory calibration, DN ≤ 200, ≤ 8 inch	D35
ISO/IEC 17025 accredited, 5-point, matched-pair factory calibration, DN 250 ... 600, 10 ... 24 inch	D36
ISO/IEC 17025 accredited, 5-point, matched-pair factory calibration, DN 700 ... 1200, 28 ... 48 inch	D37
General safety	
CSA General Purpose	E06

SITRANS FM (electromagnetic)

Flow sensors

SITRANS FMS300

Selection and ordering data (continued)

Selection and Ordering data Additional information	Order code
Drinking water approvals	
WRAS (WRc, BS 6920, GB)	E80
NSF/ANSI 61 (Cold water, US)	E81
ACS (France)	E82
DVGW-W270 (Germany)	E83
Belgaqua (Belgium)	E84
AS/NZS 4020 (Australia/New Zealand)	E85
GB/T 5750 (China)	E86
Country of origin	
France	E90
Communication	
HART with 4 ... 20 mA output, active or passive	F01
Modbus RTU / RS485	F04
PROFIBUS PA	F05
PROFIBUS DP	F06
PROFINET	F07
EtherNet/IP	F09
I/O extension	
Digital input or output, passive	F30
Device options	
Sensor terminal board factory mounted	J00
Sensor cables factory mounted	J01
Factory preconfigured for transmitter mounting in compact design (integral mount)	J02
Display with protection cover	J03
Industrial Micro-SD memory card, 8 GB storage capacity	J06
Grounding electrodes (Rubber lining)	
Without	J40
Stainless steel AISI 316Ti / 1.4571	J41
Hastelloy C276 / 2.4819	J42
Titanium	J44
Grounding electrodes (PTFE / PFA lining)	
Without	J50
Stainless steel AISI 316Ti / 1.4571	J51
Hastelloy C276 / 2.4819 (PFA: Hastelloy C22 / 2.4602)	J52
Platinum	J53
Titanium	J54
Tantalum	J55
Type of protection (IP)	
IP68 (NEMA 6P) protection type for sensor and transmitter, without potting (to 2 m depth, 10 days)	L50
IP68 (NEMA 6P) protection class for sensor in remote design, factory potted (to 10 m depth, continuously)	L51
Sensor cables	
Cable kit with coil and electrode cable, standard type (3 × 1.5 mm ²), PVC jacket	
• 5 m (16 ft)	T00
• 10 m (33 ft)	T01
• 20 m (65 ft)	T03
• 30 m (98 ft)	T05
• 40 m (131 ft)	T06
• 50 m (164 ft)	T07
• 60 m (197 ft)	T08
• 100 m (328 ft)	T11
• 150 m (492 ft)	T14
• 200 m (656 ft)	T16

Selection and Ordering data Additional information	Order code
• 500 m (1640 ft)	T18
Cable kit with coil cable standard type (3 × 1.5 mm ²) and electrode cable special type (3 × 0.25 mm ²), PVC jacket	
• 5 m (16 ft)	T50
• 10 m (33 ft)	T51
• 15 m (49 ft)	T52
• 20 m (65 ft)	T53
• 25 m (82 ft)	T54
• 30 m (98 ft)	T55
• 40 m (131 ft)	T56
• 50 m (164 ft)	T57
• 60 m (197 ft)	T58
• 100 m (328 ft)	T61
• 150 m (492 ft)	T64
• 200 m (656 ft)	T66
• 500 m (1640 ft)	T68
Device settings	
Measuring range setting: Upper range value (Q _{max}), unit	Y01
Current output damping	Y02
Current output signal range	Y03
Low flow cut off	Y04
Flow direction (Default setting: Positive)	Y05
Empty pipe detection (Default setting: On)	Y06
Mains frequency (Default setting: 50 Hz)	Y07
Operation language display (Default setting: English)	Y24
Device address (PROFIBUS 0 ... 125)	Y25
Device identification	
Location designation (TAG), device parameter and stainless-steel plate for transmitter (max. 32 characters)	Y11
Measuring point description, device parameter and stainless-steel plate for transmitter (max. 32 characters)	Y12
Location designation (TAG), device parameter and adhesive label for transmitter (max. 32 characters)	Y13
Measuring point description, device parameter and adhesive label for transmitter (max. 32 characters)	Y14
Location designation (TAG), device parameter and stainless-steel plate (max. 32 characters)	Y15
Measuring point description, device parameter and stainless-steel plate (max. 32 characters)	Y16
Location designation (TAG), device parameter and adhesive label (max. 32 characters)	Y18
Measuring point description, device parameter and adhesive label (max. 32 characters)	Y19
Totalizer 1 settings	
Preset value	Y30
Unit (Default setting: m3)	Y31
Direction (Default setting: Forward counting)	Y32
Failure mode (Default setting: Continue counting)	Y33
Decimal places (Default setting: 2)	Y34
Totalizer 2 settings	
Preset value	Y35
Unit (Default setting: m3)	Y36
Direction (Default setting: Backward counting)	Y37
Failure mode (Default setting: Continue counting)	Y38
Decimal places (Default setting: 2)	Y39
Totalizer 3 settings	
Preset value	Y40
Unit (Default setting: m3)	Y41

Selection and ordering data (continued)

Selection and Ordering data	Order code
Additional information	
Direction (Default setting: Forward / backward counting, net)	Y42
Failure mode (Default setting: Continue counting)	Y43
Decimal places (Default setting: 2)	Y44
Pulse output settings	
Volume per pulse	Y50
Pulse width	Y51

Accessories for FMS300

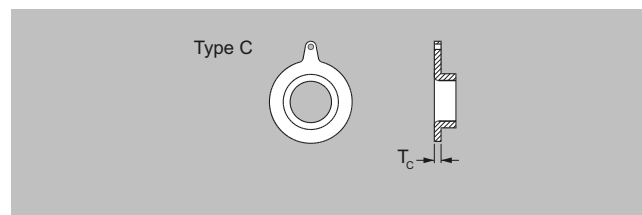
Grounding and protection ring - Type C ¹⁾

- Material: Stainless steel AISI 304
- For all liners except PTFE and PFA
- 1 pc.

Size DN	EN 1092-1 PN 6	PN 10	PN 16	PN 25	PN 40	AS 2129 Table E
	Article No.	Article No.	Article No.	Article No.	Article No.	Article No.
DN 25					FDK:083N8361	FDK:083N8361
DN 40					FDK:083N8362	FDK:083N8362
DN 50					FDK:083N8344	FDK:083N8344
DN 65	FDK:083N8345		FDK:083N8345		FDK:083N8345	FDK:083N8346
DN 80	FDK:083N8347		FDK:083N8347		FDK:083N8347	FDK:083N8347
DN 100	FDK:083N8070		FDK:083N8025		FDK:083N8025	FDK:083N8025
DN 125	FDK:083N8071		FDK:083N8071		FDK:083N8071	FDK:083N8071
DN 150	FDK:083N8072		FDK:083N8008		FDK:083N8073	FDK:083N8008
DN 200	FDK:083N8074	FDK:083N8011	FDK:083N8011	FDK:083N8011	FDK:083N8075	FDK:083N8011
DN 250	FDK:083N8078	FDK:083N8013	FDK:083N8013	FDK:083N8013	FDK:083N8079	FDK:083N8013
DN 300	FDK:083N8080	FDK:083N8012	FDK:083N8012	FDK:083N8081	FDK:083N8082	FDK:083N8012
DN 350	FDK:083N8083	FDK:083N8039	FDK:083N8039	FDK:083N8084	FDK:083N8085	FDK:083N8039
DN 400	FDK:083N8099	FDK:083N8100	FDK:083N8100	FDK:083N8101	FDK:083N8102	FDK:083N8100
DN 450	FDK:083N8103	FDK:083N8103	FDK:083N8104	FDK:083N8104	FDK:083N8105	FDK:083N8104
DN 500	FDK:083N8107	FDK:083N8107	FDK:083N8108	FDK:083N8108	FDK:083N8109	FDK:083N8108
DN 600	FDK:083N8111	FDK:083N8111	FDK:083N8112	FDK:083N8112		FDK:083N8113
DN 700	FDK:083N8300	FDK:083N8294	FDK:083N8294			FDK:083N8372
DN 750						
DN 800	FDK:083N8303	FDK:083N8304	FDK:083N8304			FDK:083N8373
DN 900	FDK:083N8306	FDK:083N8307	FDK:083N8307			FDK:083N8396
DN 1000	FDK:083N8309	FDK:083N8310	FDK:083N8310			FDK:083N8397
DN 1100		FDK:083N8367	FDK:083N8367			FDK:083N8367
DN 1200	FDK:083N8312	FDK:083N8313	FDK:083N8313			FDK:083N8398
DN 1400	FDK:083N8467	FDK:083N8468	FDK:083N8469			
DN 1500	FDK:083N8471	FDK:083N8472	FDK:083N8473			
DN 1600	FDK:083N8475	FDK:083N8476	FDK:083N8477			
DN 1800	FDK:083N8479	FDK:083N8480	FDK:083N8481			
DN 2000	FDK:083N8483	FDK:083N8484	FDK:083N8485			

Size Inch	ANSI B16.5 Class 150	Class 300	JIS B 2220:2004 10K	20K	AWWA C-207 Class D
	Article No.	Article No.	Article No.	Article No.	
1"	FDK:083N8361	FDK:083N8361	FDK:083N8361	FDK:083N8361	
1½"	FDK:083N8362	FDK:083N8362	FDK:083N8362	FDK:083N8362	
2"	FDK:083N8344	FDK:083N8344	FDK:083N8344	FDK:083N8344	
2½"	FDK:083N8345	FDK:083N8345	FDK:083N8345	FDK:083N8345	
3"	FDK:083N8347	FDK:083N8347	FDK:083N8347	FDK:083N8347	

SITRANS FM (electromagnetic)

Flow sensors

SITRANS FMS300

Selection and ordering data (continued)

Size Inch	ANSI B16.5		JIS B 2220:2004		AWWA C-207 Class D
	Class 150	Class 300	10K	20K	
4"	FDK:083N8025	FDK:083N8025	FDK:083N8070	FDK:083N8025	
5"	FDK:083N8071	FDK:083N8071	FDK:083N8071	FDK:083N8071	
6"	FDK:083N8008	FDK:083N8073	FDK:083N8008	FDK:083N8008	
8"	FDK:083N8011	FDK:083N8076	FDK:083N8011	FDK:083N8011	
10"	FDK:083N8013	FDK:083N8079	FDK:083N8013	FDK:083N8079	
12"	FDK:083N8012	FDK:083N8082	FDK:083N8012	FDK:083N8081	
14"	FDK:083N8039	FDK:083N8085	FDK:083N8083	FDK:083N8039	
16"	FDK:083N8100	FDK:083N8102	FDK:083N8100	FDK:083N8101	
18"	FDK:083N8104	FDK:083N8106	FDK:083N8103	FDK:083N8104	
20"	FDK:083N8107	FDK:083N8110	FDK:083N8107	FDK:083N8108	
24"	FDK:083N8113	FDK:083N8114	FDK:083N8111	FDK:083N8112	
28"					FDK:083N8302
30"					FDK:083N8366
32"					FDK:083N8305
36"					FDK:083N8308
40"					FDK:083N8311
42"					FDK:083N8394
44"					FDK:083N8395
48"					FDK:083N8314
54"					FDK:083N8470
60"					FDK:083N8474
66"					FDK:083N8478
72"					FDK:083N8482
80"					FDK:083N8486

¹⁾ Also for FMS500 (7ME653 DN > 300 / 12")

Grounding and protection ring - Type E

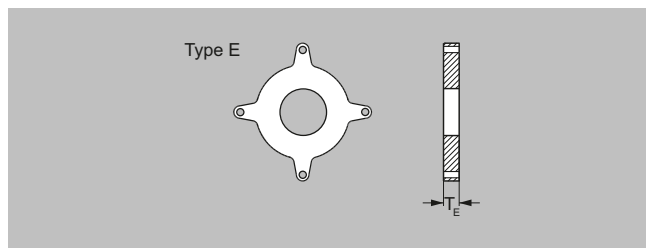

- Material: Stainless steel AISI 316

- Only for PTFE liner

- 1 pc. incl. straps and screws

Note:

For use as protection ring order 2 pcs. For use as grounding ring order 1 pc.

Size DN	EN 1092-1					AS 2129 Table E
	PN 6	PN 10	PN 16	PN 25	PN 40	
	Article No.	Article No.	Article No.	Article No.	Article No.	Article No.
DN 15					FDK:083N8365	FDK:083N8365
DN 25					FDK:083N8271	FDK:083N8272
DN 40					FDK:083N8278	FDK:083N8280
DN 50					FDK:083N8282	FDK:083N8281
DN 65	FDK:083N8284		FDK:083N8285		FDK:083N8286	FDK:083N8284
DN 80	FDK:083N8288		FDK:083N8289		FDK:083N8290	FDK:083N8293
DN 100	FDK:083N8116		FDK:083N8117		FDK:083N8118	FDK:083N8117
DN 125	FDK:083N8120		FDK:083N8121		FDK:083N8122	FDK:083N8121
DN 150	FDK:083N8124		FDK:083N8125		FDK:083N8126	FDK:083N8128
DN 200	FDK:083N8129	FDK:083N8130	FDK:083N8130	FDK:083N8131	FDK:083N8132	FDK:083N8134
DN 250	FDK:083N8135	FDK:083N8136	FDK:083N8137	FDK:083N8138	FDK:083N8139	FDK:083N8143

Selection and ordering data (continued)

Size DN	EN 1092-1 PN 6	PN 10	PN 16	PN 25	PN 40	AS 2129 Table E
DN 300	FDK:083N8144	FDK:083N8144	FDK:083N8145	FDK:083N8146	FDK:083N8147	FDK:083N8151
DN 350	FDK:083N8152	FDK:083N8153	FDK:083N8154	FDK:083N8155	FDK:083N8156	FDK:083N8153
DN 400	FDK:083N8160	FDK:083N8161	FDK:083N8162	FDK:083N8163	FDK:083N8164	FDK:083N8161
DN 450	FDK:083N8168	FDK:083N8169	FDK:083N8170	FDK:083N8171	FDK:083N8172	FDK:083N8176
DN 500	FDK:083N8177	FDK:083N8178	FDK:083N8179	FDK:083N8180	FDK:083N8181	FDK:083N8185
DN 600	FDK:083N8186	FDK:083N8187	FDK:083N8188	FDK:083N8189		A5E32710253

Size Inch	ANSI B16.5 Class 150	Class 300	JIS B 2220:2004 10K	20K
	Article No.	Article No.	Article No.	Article No.
½"	FDK:083N8365	FDK:083N8365		
1"	FDK:083N8272	FDK:083N8272	FDK:083N8271	FDK:083N8271
1½"	FDK:083N8279	FDK:083N8279	FDK:083N8278	FDK:083N8278
2"	FDK:083N8283	FDK:083N8283	FDK:083N8282	FDK:083N8282
2½"	FDK:083N8287	FDK:083N8287	FDK:083N8285	FDK:083N8285
3"	FDK:083N8291	FDK:083N8292	FDK:083N8288	FDK:083N8289
4"	FDK:083N8118	FDK:083N8119	FDK:083N8116	FDK:083N8117
5"	FDK:083N8122	FDK:083N8123	FDK:083N8121	FDK:083N8122
6"	FDK:083N8126	FDK:083N8127	FDK:083N8125	FDK:083N8126
8"	FDK:083N8370	FDK:083N8133	FDK:083N8130	FDK:083N8370
10"	FDK:083N8140	FDK:083N8141	FDK:083N8137	FDK:083N8139
12"	FDK:083N8148	FDK:083N8149	FDK:083N8144	FDK:083N8146
14"	FDK:083N8157	FDK:083N8158	FDK:083N8152	FDK:083N8154
16"	FDK:083N8165	FDK:083N8166	FDK:083N8160	FDK:083N8165
18"	FDK:083N8173	FDK:083N8174	FDK:083N8169	FDK:083N8171
20"	FDK:083N8182	FDK:083N8183	FDK:083N8178	FDK:083N8180
24"	FDK:083N8190	FDK:083N8191	A5E32709738	A5E32710253

Grounding and protecting ring - Type E

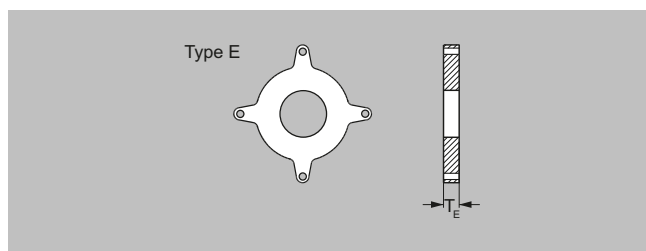

- Material: Hastelloy C276
- Only for PTFE liner
- 1 pc. incl. straps and screws

Note:

For use as protection ring order 2 pcs. For use as grounding ring order 1 pc.

Size DN	EN 1092-1 PN 6	PN 16	PN 40	Size Inch	ANSI B16.5 Class 150	Class 300
	Article No.	Article No.	Article No.		Article No.	Article No.
DN 15			FDK:083N8487	½"	FDK:083N8487	FDK:083N8487
DN 25			FDK:083N8488	1"	FDK:083N8489	FDK:083N8489
DN 40			FDK:083N8490	1½"	FDK:083N8491	FDK:083N8491
DN 50			FDK:083N8492	2"	FDK:083N8493	FDK:083N8493
DN 65	FDK:083N8494	FDK:083N8495	FDK:083N8496	2½"	FDK:083N8497	FDK:083N8497
DN 80	FDK:083N8498	FDK:083N8499	FDK:083N8500	3"	FDK:083N8501	FDK:083N8502
DN 100	FDK:083N8503	FDK:083N8504	FDK:083N8505	4"	FDK:083N8506	FDK:083N8507

SITRANS FM (electromagnetic)

Flow sensors

SITRANS FMS300

Selection and ordering data (continued)

Grounding ring - Type Flat ring

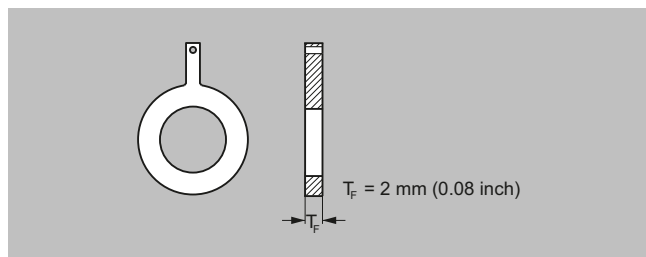

- Material: Stainless steel AISI 316
- For all liners
- 1 pc.

Size DN	EN 1092-1 PN 10	PN 16	PN 40	Size Inch	ANSI B16.5 Class 150	Class 300
	Article No.	Article No.	Article No.		Article No.	Article No.
DN 15			A5E01191968	½"	A5E01191969	
DN 25			A5E01150880	1"	A5E01150022	A5E01150378
DN 40			A5E01191952	1½"	A5E01191961	
DN 50		A5E01192006	A5E01150918	2"	A5E01151121	A5E01151194
DN 65		A5E01191940	A5E01191954	2½"	A5E01191962	
DN 80		A5E01152876	A5E01152876	3"	A5E01152910	A5E01153422
DN 100		A5E01158875	A5E01159072	4"	A5E01159146	A5E01159628
DN 125		A5E01191941	A5E01191956	5"	A5E01191963	
DN 150		A5E01191943	A5E01191957	6"	A5E01191964	
DN 200	A5E01191951	A5E01191944	A5E01191958	8"	A5E01191965	
DN 250	A5E01191950	A5E01191946	A5E01191959	10"	A5E01191966	
DN 300	A5E01191949	A5E01191947	A5E01191960	12"	A5E01191967	

Grounding ring - Type Flat ring

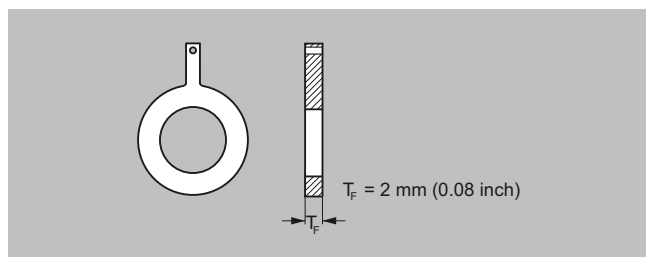

- Material: Hastelloy C276
- For all liners
- 1 pc.

Size DN	EN 1092-1 PN 6	PN 16	PN 40	Size Inch	ANSI B16.5 Class 150	Class 300
	Article No.	Article No.	Article No.		Article No.	Article No.
DN 15			A5E01191981	½"	A5E01191989	
DN 25			A5E01150882	1"	A5E01150028	A5E01150379
DN 40			A5E01191982	1½"	A5E01191990	
DN 50		A5E01192006	A5E01150922	2"	A5E01151124	A5E01151197
DN 65		A5E01191971	A5E01191983	2½"	A5E01191991	
DN 80		A5E01152889	A5E01152889	3"	A5E01152913	A5E01153424
DN 100		A5E01158886	A5E01159074	4"	A5E01159150	A5E01159629
DN 125		A5E01191973	A5E01191984	5"	A5E01191992	
DN 150		A5E01191974	A5E01191985	6"	A5E01191993	
DN 200	A5E01191978	A5E01191975	A5E01191986	8"	A5E01191994	
DN 250	A5E01191979	A5E01191976	A5E01191987	10"	A5E01191995	
DN 300	A5E01191980	A5E01191977	A5E01191988	12"	A5E01191996	

Selection and ordering data (continued)

Grounding ring - Type Flat ring

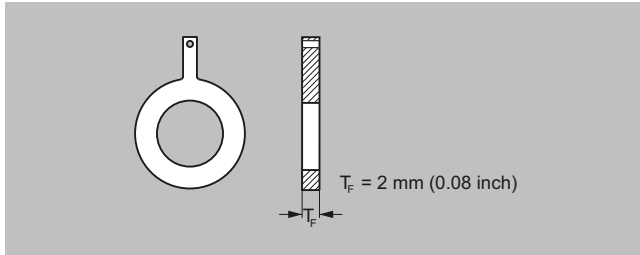

- Material: Tantalum
- For all liners
- 1 pc.

Size DN	EN 1092-1 PN 16	PN 40	Size Inch	ANSI B16.5 Class 150	Class 300
	Article No.	Article No.		Article No.	Article No.
DN 15		A5E01192007	½"	A5E01192010	
DN 25		A5E01150883	1"	A5E01150030	A5E01150381
DN 40		A5E01192008	1½"	A5E01192011	
DN 50	A5E01192006	A5E01150926	2"	A5E01151129	A5E01151199
DN 65	A5E01192005	A5E01192009	2½"	A5E01192012	
DN 80	A5E01152890	A5E01152890	3"	A5E01152916	A5E01153427
DN 100	A5E01158891	A5E01159076	4"	A5E01159156	A5E01159631

SITRANS FM (electromagnetic)

Flow sensors

SITRANS FMS300

Technical specifications

SITRANS FMS300	
Product characteristic	Versatile product to meet the diverse demands of various industries such as process, chemical, steel, mining, utility, power generation and distribution, oil and gas/HPI, water and wastewater
Measurement of	Volume flow, flow velocity, electrical conductivity
Nominal diameter	Full bore sensor: DN 15 ... 2200 (½" ... 88")
Mode of operation	
Measuring principle	Electromagnetic induction
Medium conductivity	Liquids with an electrical conductivity $\geq 5 \mu\text{S/cm}$
Excitation frequency (mains supply: 50 Hz / 60 Hz)	DN 15 ... 65 (½" ... 2½ inch): 12.5 Hz / 15 Hz DN 80 ... 150 (3 ... 6 inch): 6.25 Hz / 7.5 Hz DN 200 ... 1200 (8 ... 48 inch): 3.125 Hz / 3.75 Hz DN 1400 ... 2200 (54 ... 88 inch): 1.5625 Hz / 1.875 Hz
Performance characteristics	
Electrical conductivity	Repeatability: Max. $\pm 5\%$ of measured value ⁴⁾
Process connection	
Flanges	
• EN 1092-1 ^{1) 2)}	PN 6 (87 psi) Raised face DN 65 ... 2200 (2½" ... 88 inch) PN 10 (145 psi) Raised face DN 200 ... 2200 (8 ... 88 inch) PN 16 (232 psi) Raised face DN 65 ... 2000 (2 ½" ... 80 inch) PN 25 (362 psi) Raised face DN 200 ... 600 (8 ... 24 inch) PN 40 (580 psi) Raised face DN 15 ... 600 (½" ... 24 inch) PN 63 (913 psi) Raised face DN 50 ... 300 (2 ... 12 inch) PN 100 (1450 psi) Raised face DN 25 ... 300 (1 ... 12 inch)
• ANSI B16.5	Class 150 (290 psi) Raised face ½" ... 24 inch Class 300 (725 psi) Raised face ½" ... 24 inch Class 600 (1450 psi) Raised face 1" ... 16 inch
• AWWA C-207	Class D (145 psi) Flat face 28 ... 88 inch
• AS 2129	Table E (145 psi) Raised face DN 15 ... 1200 (½" ... 48 inch)
• AS 4087 ¹⁾	PN 16 (232 psi) Raised face DN 50 ... 1200 (2 ... 48 inch) PN 21 (304 psi) Raised face DN 50 ... 600 (2 ... 24 inch) PN 35 (508 psi) Raised face DN 50 ... 600 (2 ... 24 inch)
• JIS B 2220:2004	10K DN 25 ... 600 (1 ... 24 inch) 20K DN 25 ... 600 (1 ... 24 inch)
Rated operating conditions	
Ambient temperature	
(conditions also dependent on material characteristics)	
• Sensor	-40 ... +100 °C (-40 ... +212 °F)
• Compact with transmitter	-40 ... +65 °C (-40 ... +149 °F)
Operating pressure [abs] (Maximum operating pressure depending on flange type)	Soft rubber (Neoprene): 0.01 ... 100 bar (0.15 ... 1450 psi) EPDM: 0.01 ... 40 bar (0.15 ... 580 psi) Linatex: 0.01 ... 40 bar (0.15 ... 580 psi) Ebonite: 0.01 ... 100 bar (0.15 ... 1450 psi) PTFE: - DN ≤ 300 ($\leq 12"$): 0.3 ... 50 bar (4 ... 725 psi) - $350 \leq \text{DN} \leq 600$ ($14" \leq \text{DN} \leq 24"$): 0.3 ... 40 bar (4 ... 580 psi) PFA: Vacuum 0.02 ... 50 bar (0.29 ... 725 psi)
Temperature of medium	
• Softrubber	0 ... +70 °C (32 ... 158 °F)
• EPDM	-10 ... +70 °C (14 ... 158 °F)
• PTFE	-20 ... +100 °C (-4 ... +212 °F)
• Ebonite	0 ... 95 °C (32 ... 203 °F)

Technical specifications (continued)

SITRANS FMS300	
• Linatex	-40 ... +70 °C (-40 ... +158 °F)
• PFA	-20 ... +100 °C (-4 ... +212 °F)
Degree of protection	
• Standard	IP66/67, NEMA 4X/6
• Optional	IP68 and NEMA 6P (2 m, 10 days) IP68 and NEMA 6P (10 m, continuously) (only in remote design)
Mechanical load (vibration)	
• Integral mount / compact version	Vibration, sinusoidal according to IEC 60068-2-6: - 2 ... 8.4 Hz, 3.5 mm peak - 8.4 ... 500 Hz, 1 g peak Vibration broad-band random, according to IEC 60068-2-64: - 10 ... 200 Hz, 0.003 g ² /Hz - 200 ... 500 Hz, 0.001 g ² /Hz - Total: 1.54 g rms
• Remote Version	Vibration, sinusoidal according to IEC 60068-2-6: Sensor - 2 ... 8.4 Hz, 7.5 mm peak - 8.4 ... 500 Hz, 2 g peak Transmitter - 2 ... 8.4 Hz, 1.5 mm peak - 8.4 ... 500 Hz, 0.7 g peak Vibration broad-band random, according to IEC 60068-2-64: Sensor - 10 ... 200 Hz, 0.01 g ² /Hz - 200 ... 500 Hz, 0.003 g ² /Hz - Total: 1.54 g rms Transmitter - 10 ... 200 Hz, 0.003 g ² /Hz - 200 ... 500 Hz, 0.001 g ² /Hz - Total: 1.54 g rms
Pressure drop	Insignificant (as for straight pipe)
Test pressure	1.5 × PN (where applicable)
Design	
Dimensions	See dimensional drawings
Weight	See dimensional drawings
Material	
• Sensor housing and flanges	• Carbon steel ASTM A 105 with corrosion-resistant coating acc. to EN ISO 12944 class C4 or C5 (durability up to 15 years) • Stainless steel AISI 304 / 1.4301 flanges and carbon steel sensor housing with corrosion-resistant coating acc. to EN ISO 12944 class C4 or C5 (durability up to 15 years) • Stainless steel AISI 316L / 1.4404 flanges and sensor housing, polished
• Measuring electrode	• Stainless steel AISI 316Ti / 1.4571 • Hastelloy C276 / 2.4819 (PFA: Hastelloy C22 / 2.4602) • Platinum • Titanium • Tantalum • Ceramic coated stainless steel AISI 316Ti / 1.4571 • Ceramic coated Hastelloy C276 / 2.4819

Technical specifications (continued)

SITRANS FMS300	
• Grounding electrode	<ul style="list-style-type: none"> • Stainless steel AISI 316Ti / 1.4571 - Standard: Soft rubber, EPDM, Ebonite and Linatex - Optional: PTFE, PFA • Hastelloy C276 / 2.4819 - Standard: Soft rubber, EPDM, Ebonite and Linatex - Optional: PTFE, PFA (Hastelloy C22 / 2.4602) • Titanium - Optional: PTFE, PFA • Platinum - Optional: PTFE, PFA • Tantalum - Optional: PTFE, PFA
• Measuring tube	Stainless steel AISI 304 / 1.4301 (AISI 316Ti / 1.4571) ³⁾
• Terminal box	Polycarbonate
Cable entries	4 × metric thread (size M20 × 1.5)
Calibration	
• Standard	Zero-point, 2 × 25% and 2 × 90%
• Optional	5-point calibration: 20%, 40%, 60%, 80%, 100% of factory Q_{max} 10-point calibration: ascending and descending at 20%, 40%, 60%, 80%, 100% of factory Q_{max} Matched pair calibration: default, 5-point or 10-point ISO/IEC 17025 accredited, 5-point, matched-pair calibration
Certificates and approvals	
General purpose	CE (LVD, PED, EMC, RoHS), UKCA
Drinking water	<ul style="list-style-type: none"> • WRAS (WRc, BS 6920 material approval for cold water, GB) • NSF/ANSI Standard 61 (Cold water, US) • ACS listed (France) • DVGW W270 (Germany) • Belgaqua (Belgium) • AS/NZS 4020 (Australia / New Zealand) • GB/T 5750 (China)
Others	<ul style="list-style-type: none"> • Environmental Product Declaration (EPD) • CRN (Canadian Registration Number) • EAC (Kazakhstan)

- 1) DN 750, DN 1050 and DN 1100 (30", 42" and 44") not available with EN 1092-1 and AS 4087 flanges.
- 2) PN 6-40: DN ≤ 600 type 01 (SORF); DN > 600 type 11 (WNRF); PN 63-100: type 11 (WNRF).
- 3) Only in combination with flanges and sensor housing in stainless steel AISI 304 / 1.4301.
- 4) The value applies for measurement between 15 μS/cm and 5000 μS/cm at a reference temperature of 25 °C (77 °F).

SITRANS FM (electromagnetic)

Flow sensors

SITRANS FMS300

Dimensional drawings

SITRANS FMS300 sensor in compact (integral-mount transmitter) and remote design.

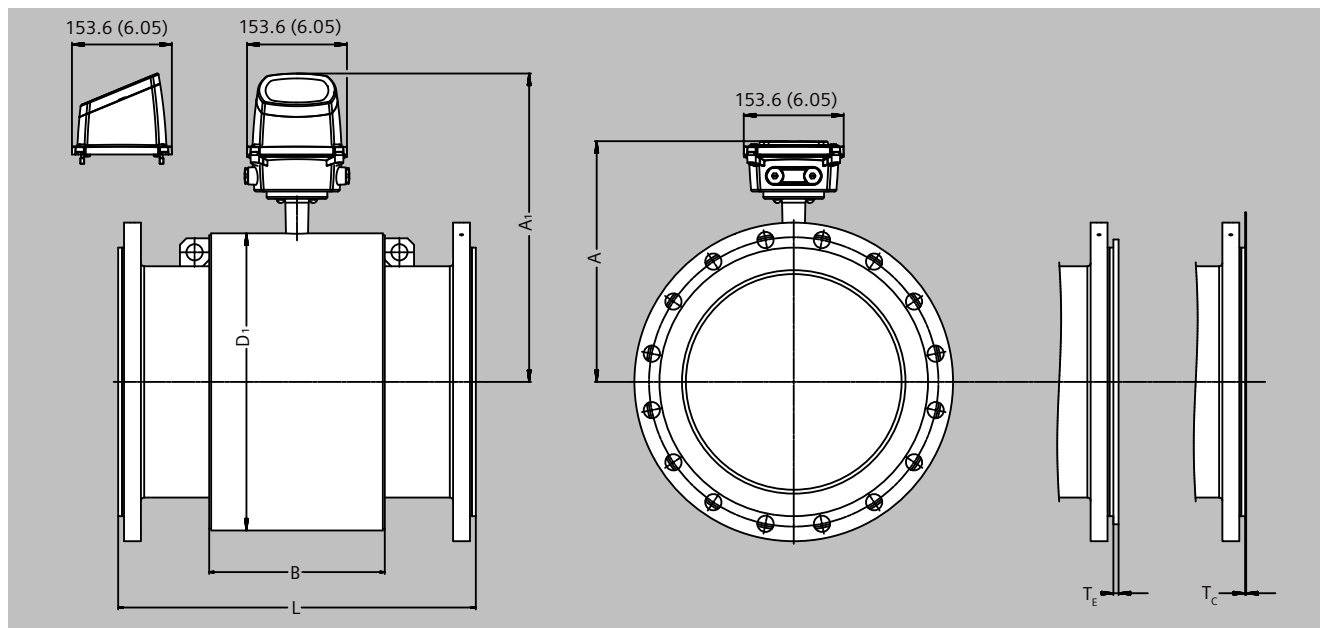

Dimensions in mm (inch)

Metric

DN	A	A ₁	B	D1	L ¹⁾					
					EN 1092-1		PN 25	PN 40	PN 63	PN 100
					PN 6, PN 10	PN 16 std./ PN 16 length- h 1.0 × DN				
[mm]	[mm]	[mm]	[mm]	[mm]	[mm]	[mm]	[mm]	[mm]	[mm]	[mm]
15	180	284	59	104	-	-/-	-	200	-	-
25	180	284	59	104	-	-/-	-	200	-	260 ²⁾
32	190	294	86	114	-	-/-	-	200	-	280 ²⁾
40	190	294	82	124	-	-/-	-	200	-	280 ²⁾
50	198	302	72	139	-	-/-	-	200	276 ²⁾	300 ²⁾
65	205	309	72	154	200	200/-	-	200	320 ²⁾	350 ²⁾
80	215	319	72	174	200	200/-	-	272 ²⁾	323 ²⁾	340 ²⁾
100	235	339	85	214	250	250/-	-	250	380 ²⁾	400 ²⁾
125	248	352	85	239	250	250/-	-	250	420 ²⁾	450 ²⁾
150	269	373	85	282	300	300/-	-	300	415 ²⁾	450 ²⁾
200	297	401	137	338	350	350/-	350	350	480 ²⁾	530 ²⁾
250	325	429	157	393	450	450/-	450	450	550 ²⁾	620 ²⁾
300	350	454	157	444	500	500/-	500	500	600 ²⁾	680 ²⁾
350	355	459	270	451	550	550/-	550	550	-	-
400	380	484	270	502	600	600/-	600	600	-	-
450	411	515	310	563	600	600/-	600	600	-	-
500	436	540	350	614	600	600/-	625	680	-	-
600	487	591	320	715	600	600/-	750	800	-	-
700	537	641	450	816	700	875/700	800	-	-	-
750	564	668	556	869	-	-/-	-	-	-	-
800	599	703	560	927	800	1000/800	900	-	-	-
900	646	750	630	1032	900	1125/900	1000	-	-	-
1000	697	801	670	1136	1000	1250/1000	1100	-	-	-
1050	697	801	670	1136	-	-/-	-	-	-	-

Dimensional drawings (continued)

DN	A	A ₁	B	D1	L ¹⁾					
					EN 1092-1 PN 6, PN 10		PN 16 std./ PN 16 length- h 1.0 × DN	PN 25	PN 40	PN 63
[mm]	[mm]	[mm]	[mm]	[mm]	[mm]	[mm]	[mm]	[mm]	[mm]	[mm]
1100	748	847	770	1238	-	-/-	-	-	-	-
1200	803	907	792	1348	1200	1500/1200	1300	-	-	-
1400	918	1022	1000	1574	1400	-/1400	-	-	-	-
1500	965	1069	1020	1672	1500	-/1500	-	-	-	-
1600	1018	1122	1130	1774	1600	-/1600	-	-	-	-
1800	1116	1220	1250	1974	1800	-/1800	-	-	-	-
2000	1216	1320	1375	2174	2000	-/2000	-	-	-	-
2200	1346	1450	1496	2400	2200	-/-	-	-	-	-

1) When grounding or protection rings are used, the thickness of the grounding or protection ring must be added to the sensor face-to-face length

2) Not according to ISO 20456

DN	A	A ₁	B	D1	L ¹⁾			AWWA C-2- AS 4087		AS 2129
					ANSI B16.5			07		
					Class 150	Class 300	Class 600	Class D	PN 16, PN 21, PN 35	Table E
[mm]	[mm]	[mm]	[mm]	[mm]	[mm]	[mm]	[mm]	[mm]	[mm]	[mm]
15	180	284	59	104	200	200	-	-	-	200
25	180	284	59	104	200	200	280 ³⁾	-	-	200
32	190	294	86	114	200	200	300 ³⁾	-	-	200
40	190	294	82	124	200	200	320 ³⁾	-	-	200
50	198	302	72	139	200	200	330 ³⁾	-	200	200
65	205	309	72	154	200	272 ³⁾	370 ³⁾	-	200	200
80	215	319	72	174	272 ³⁾	272 ³⁾	350 ³⁾	-	272 ²⁾³⁾	272 ³⁾
100	235	339	85	214	250	310 ³⁾	460 ³⁾	-	250	250
125	248	352	85	239	250	335 ³⁾	480 ³⁾	-	-	250
150	269	373	85	282	300	300	500 ³⁾	-	300	300
200	297	401	137	338	350	350	600 ³⁾	-	350	350
250	325	429	157	393	450	450	600 ³⁾	-	450	450
300	350	454	157	444	500	500	700 ³⁾	-	500	500
350	355	459	270	451	550	550	800 ³⁾	-	550	550
400	380	484	270	502	600	600	820 ³⁾	-	600	600
450	411	515	310	563	600	640	-	-	600	600
500	436	540	350	614	600	730	-	-	600 ⁴⁾	600
600	487	591	320	715	600	860	-	-	600 ⁵⁾	600
700	537	641	450	816	800	-	-	700	700 ⁶⁾	700
750	564	668	556	869	950	-	-	750	-	750
800	599	703	560	927	900	-	-	800	800 ⁶⁾	800
900	646	750	630	1032	1100	-	-	900	900 ⁶⁾	900
1000	697	801	670	1136	1100	-	-	1000	1000 ⁶⁾	1000
1050	697	801	670	1136	-	-	-	1000	-	-
1100	748	847	770	1238	-	-	-	1100	-	-
1200	803	907	792	1348	1400	-	-	1200	1200 ⁶⁾	1200
1400	918	1022	1000	1574	-	-	-	1400	-	-
1500	965	1069	1020	1672	-	-	-	1500	-	-
1600	1018	1122	1130	1774	-	-	-	1600	-	-
1800	1116	1220	1250	1974	-	-	-	1800	-	-
2000	1216	1320	1375	2174	-	-	-	2000	-	-
2200	1346	1450	1496	2400	-	-	-	2200	-	-

1) When grounding or protection rings are used, the thickness of the grounding or protection ring must be added to the sensor face-to-face length

2) AS 4087, PN 35, DN 80 = 272 mm

3) Not according to ISO 20456

4) AS 4087, PN 35, DN 500 = 680 mm

5) AS 4087, PN 35, DN 600 = 750 mm

6) Not available for AS 4087, PN 21 or PN 35

SITRANS FM (electromagnetic)

Flow sensors

SITRANS FMS300

Dimensional drawings (continued)

DN	A	A ₁	B	D1	L ¹⁾		T _C ²⁾	T _E ²⁾	T _F ²⁾	Weight
					JIS B 2220:2004					
[mm]	[mm]	[mm]	[mm]	[mm]	10K [mm]	20K [mm]	[mm]	[mm]	[mm]	[kg]
15	180	284	59	104	200	200	-	6.0	2.0	4
25	180	284	59	104	200	200	1.2	6.0	2.0	5
32	190	294	86	114	200	240 ³⁾	1.2	6.0	2.0	7
40	190	294	82	124	200	240 ³⁾	1.2	6.0	2.0	8
50	198	302	72	139	200	240 ³⁾	1.2	6.0	2.0	9
65	205	309	72	154	200	272 ³⁾	1.2	6.0	2.0	11
80	215	319	72	174	200	272 ³⁾	1.2	6.0	2.0	12
100	235	339	85	214	250	310 ³⁾	1.2	6.0	2.0	16
125	248	352	85	239	250	335 ³⁾	1.2	6.0	2.0	19
150	269	373	85	282	300	300	1.2	6.0	2.0	27
200	297	401	137	338	350	350	1.2	8.0	2.0	40
250	325	429	157	393	450	450	1.2	8.0	2.0	60
300	350	454	157	444	500	500	1.6	8.0	2.0	80
350	355	459	270	451	550	550	1.6	8.0	-	110
400	380	484	270	502	600	600	1.6	10.0	-	125
450	411	515	310	563	600	640	1.6	10.0	-	175
500	436	540	350	614	600	680	1.6	10.0	-	200
600	487	591	320	715	600	800	1.6	10.0	-	287
700	537	641	450	816	-	-	2.0	-	-	330
750	564	668	556	869	-	-	2.0	-	-	360
800	599	703	560	927	-	-	2.0	-	-	450
900	646	750	630	1032	-	-	2.0	-	-	530
1000	697	801	670	1136	-	-	2.0	-	-	660
1050	697	801	670	1136	-	-	2.0	-	-	660
1100	748	847	770	1238	-	-	2.0	-	-	1140
1200	803	907	792	1348	-	-	2.0	-	-	1180
1400	918	1022	1000	1574	-	-	2.0	-	-	1600
1500	965	1069	1020	1672	-	-	3.0	-	-	2460
1600	1018	1122	1130	1774	-	-	3.0	-	-	2525
1800	1116	1220	1250	1974	-	-	3.0	-	-	2930
2000	1216	1320	1375	2174	-	-	3.0	-	-	3665
2200	1346	1450	1496	2400	-	-	-	-	-	5690

¹⁾ When grounding or protection rings are used, the thickness of the grounding or protection ring must be added to the sensor face-to-face length

²⁾ T_C = Protection ring type C, T_E = Grounding ring type E, T_F = Grounding ring type Flat ring

³⁾ Not according to ISO 20456

Imperial

DN	A	A ₁	B	D1	L ^{1) 2)}					
					EN 1092-1					
[inch]	[inch]	[inch]	[inch]	[inch]	PN 6, PN 10	PN 16 std./ PN 16 leng- th 1.0 × DN	PN 25	PN 40	PN 63	PN 100
1/2"	7.36	13.31	2.32	4.09	-	-/-	-	7.87	-	-
1"	7.36	13.31	2.32	4.09	-	-/-	-	7.87	-	10.24 ²⁾
1 1/4"	7.6	13.6	3.4	4.5	-	-/-	-	7.87	-	11.02 ²⁾
1 1/2"	7.76	13.7	3.23	4.88	-	-/-	-	7.87	-	11.02 ²⁾
2"	8.07	14.01	2.83	5.47	-	-/-	-	7.87	10.87 ²⁾	11.81 ²⁾
2 1/2"	8.35	14.29	2.83	6.06	7.87	7.87/-	-	7.87	12.60 ²⁾	13.78 ²⁾
3"	8.74	14.69	2.83	6.85	7.87	7.87/-	-	10.71 ²⁾	12.72 ²⁾	13.39 ²⁾
4"	9.53	15.47	3.35	8.43	9.84	9.84/-	-	9.84	14.96 ²⁾	15.75 ²⁾
5"	10.04	15.98	3.35	9.41	9.84	9.84/-	-	9.84	16.54 ²⁾	17.72 ²⁾
6"	10.87	16.81	5.39	11.10	11.81	11.81/-	-	11.81	16.34 ²⁾	17.72 ²⁾
8"	11.97	17.91	5.39	13.31	13.78	13.78/-	13.78	13.78	18.90 ²⁾	20.87 ²⁾
10"	13.07	19.02	6.18	15.47	17.72	17.72/-	17.72	17.72	21.65 ²⁾	24.41 ²⁾

Dimensional drawings (continued)

DN	A	A ₁	B	D1	L ^{1) 2)}					
					EN 1092-1		PN 25	PN 40	PN 63	PN 100
[inch]	[inch]	[inch]	[inch]	[inch]	PN 6, PN 10	PN 16 std./ PN 16 length 1.0 × DN				
12"	14.05	20.00	6.18	17.48	19.69	16.69/-	19.69	19.69	23.62 ²⁾	26.77 ²⁾
14"	14.25	20.20	10.63	17.76	21.65	21.65/-	21.65	21.65	-	-
16"	15.24	21.18	10.63	19.76	23.62	23.62/-	23.62	23.62	-	-
18"	16.45	22.40	12.20	22.16	23.62	23.62/-	23.62	23.62	-	-
20"	17.44	23.39	13.78	24.17	23.62	23.62/-	24.61	26.77	-	-
24"	19.45	25.39	12.59	28.15	23.62	23.62/-	29.53	31.50	-	-
28"	21.42	27.36	17.72	32.13	27.56	34.45/27.56	31.50	-	-	-
30"	22.48	28.43	21.89	34.21	-	-/-	-	-	-	-
32"	23.86	29.80	22.05	36.50	31.50	39.37/31.50	35.43	-	-	-
36"	25.71	31.65	24.80	40.63	35.43	44.29/35.43	39.38	-	-	-
40"	27.72	33.85	26.38	44.72	39.37	49.21/39.37	43.32	-	-	-
42"	27.72	33.85	26.38	44.72	-	-/-	-	-	-	-
44"	29.72	35.67	30.31	48.74	-	-/-	-	-	-	-
48"	31.89	37.83	31.18	53.07	47.24	59.06/47.24	51.19	-	-	-
54"	36.42	42.36	39.37	61.97	55.12	-/55.12	-	-	-	-
60"	38.27	44.21	40.15	65.83	59.06	-/59.06	-	-	-	-
66"	40.35	46.30	44.49	69.84	62.99	-/62.99	-	-	-	-
72"	44.21	50.16	49.21	77.72	70.87	-/70.87	-	-	-	-
80"	48.15	54.09	54.13	85.59	78.74	-/78.74	-	-	-	-
88"	53.30	59.03	58.90	94.50	86.60	-/-	-	-	-	-

¹⁾ When grounding or protection rings are used, the thickness of the grounding or protection ring must be added to the sensor face-to-face length

³⁾ Not according to ISO 20456

DN	A	A ₁	B	D1	L ¹⁾					
					ANSI B16.5		Class 600	Class D	AS 4087 PN 16, PN 21, PN 35	AS 2129 Table E
[inch]	[inch]	[inch]	[inch]	[inch]	Class 150	Class 300				
1/2"	7.36	13.31	2.32	4.09	7.87	7.87	-	-	7.87	7.87
1"	7.36	13.31	2.32	4.09	7.87	7.87	11.02 ³⁾	-	7.87	7.87
1 1/4"	7.6	13.6	3.4	4.5	7.87	7.87	11.81 ³⁾	-	7.87	7.87
1 1/2"	7.76	13.7	3.23	4.88	7.87	7.87	12.60 ³⁾	-	7.87	7.87
2"	8.07	14.01	2.83	5.47	7.87	7.87	12.99 ³⁾	-	7.87	7.87
2 1/2"	8.35	14.29	2.83	6.06	7.87	10.71 ³⁾	14.57 ³⁾	-	7.87	7.87
3"	8.74	14.69	2.83	6.85	10.71 ³⁾	10.71 ³⁾	13.78 ³⁾	-	7.87 ²⁾³⁾	7.87 ³⁾
4"	9.53	15.47	3.35	8.43	9.84	12.20 ³⁾	18.11 ³⁾	-	9.84	9.84
5"	10.04	15.98	3.35	9.41	9.84	13.19 ³⁾	18.90 ³⁾	-	-	9.84
6"	10.87	16.81	5.39	11.10	11.81	11.81	19.68 ³⁾	-	11.81	11.81
8"	11.97	17.91	5.39	13.31	13.78	13.78	23.62 ³⁾	-	13.78	13.78
10"	13.07	19.02	6.18	15.47	17.72	17.72	23.62 ³⁾	-	17.72	17.72
12"	14.05	20.00	6.18	17.48	19.69	16.69	27.56 ³⁾	-	19.69	19.69
14"	14.25	20.20	10.63	17.76	21.65	21.65	31.50 ³⁾	-	21.65	21.65
16"	15.24	21.18	10.63	19.76	23.62	23.62	32.28 ³⁾	-	23.62	23.62
18"	16.45	22.40	12.20	22.16	23.62	25.20	-	-	23.62	23.62
20"	17.44	23.39	13.78	24.17	23.62	28.70	-	-	23.62 ⁴⁾	23.62
24"	19.45	25.39	12.59	28.15	23.62	33.80	-	-	23.62 ⁵⁾	23.62
28"	21.42	27.36	17.72	32.13	31.50	-	-	27.56	27.56 ⁶⁾	27.56
30"	22.48	28.43	21.89	34.21	37.41	-	-	29.53	-	29.53
32"	23.86	29.80	22.05	36.50	35.43	-	-	31.50	31.50 ⁶⁾	31.50
36"	25.71	31.65	24.80	40.63	43.32	-	-	35.43	35.43 ⁶⁾	35.43
40"	27.72	33.85	26.38	44.72	43.32	-	-	39.37	39.37 ⁶⁾	39.37
42"	27.72	33.85	26.38	44.72	-	-	-	39.37	-	-
44"	29.72	35.67	30.31	48.74	-	-	-	43.31	-	-
48"	31.89	37.83	31.18	53.07	55.12	-	-	47.24	47.24 ⁶⁾	47.24
54"	36.42	42.36	39.37	61.97	-	-	-	55.12	-	-

SITRANS FM (electromagnetic)

Flow sensors

SITRANS FMS300

Dimensional drawings (continued)

DN	A	A ₁	B	D1	L ¹⁾					AS 4087 PN 16, PN 21, PN 35	AS 2129 Table E
					ANSI B16.5 Class 150	AWWA C-207 Class 300	Class 600	Class D	Class D		
[inch]	[inch]	[inch]	[inch]	[inch]	[inch]	[inch]	[inch]	[inch]	[inch]	[inch]	[inch]
60"	38.27	44.21	40.15	65.83	-	-	-	59.06	-	-	-
66"	40.35	46.30	44.49	69.84	-	-	-	62.99	-	-	-
72"	44.21	50.16	49.21	77.72	-	-	-	70.87	-	-	-
80"	48.15	54.09	54.13	85.59	-	-	-	78.74	-	-	-
88"	53.30	59.03	58.90	94.50	-	-	-	86.61	-	-	-

1) When grounding or protection rings are used, the thickness of the grounding or protection ring must be added to the sensor face-to-face length

2) AS 4087, PN 35, DN 80 (3") = 10.07 inch

3) Not according to ISO 20456

4) AS 4087, PN 35, DN 500 (20") = 26.77 inch

5) AS 4087, PN 35, DN 600 (24") = 29.53 inch

6) Not available for AS 4087, PN 21 or PN 35

DN	A	A ₁	B	D1	L ¹⁾		T _C ²⁾	T _E ²⁾	T _F ²⁾	Weight
					JIS B 2220:2004 10K	20K				
[inch]	[inch]	[inch]	[inch]	[inch]	[inch]	[inch]	[inch]	[inch]	[inch]	[lbs]
1/2"	7.36	13.31	2.32	4.09	7.87	7.87	-	0.24	0.08	9
1"	7.36	13.31	2.32	4.09	7.87	7.87	0.5	0.24	0.08	11
1 1/4"	7.6	13.6	3.4	4.5	7.87	9.44 ³⁾	0.5	0.24	0.08	11
1 1/2"	7.76	13.7	3.23	4.88	7.87	9.44 ³⁾	0.5	0.24	0.08	17
2"	8.07	14.01	2.83	5.47	7.87	9.44 ³⁾	0.5	0.24	0.08	20
2 1/2"	8.35	14.29	2.83	6.06	7.87	10.71 ³⁾	0.5	0.24	0.08	24
3"	8.74	14.69	2.83	6.85	7.87	10.71 ³⁾	0.5	0.24	0.08	26
4"	9.53	15.47	3.35	8.43	9.84	12.20 ³⁾	0.5	0.24	0.08	35
5"	10.04	15.98	3.35	9.41	9.84	13.19 ³⁾	0.5	0.24	0.08	42
6"	10.87	16.81	5.39	11.10	11.81	11.81	0.5	0.24	0.08	60
8"	11.97	17.91	5.39	13.31	13.78	13.78	0.5	0.31	0.08	88
10"	13.07	19.02	6.18	15.47	17.72	17.72	0.5	0.31	0.08	132
12"	14.05	20.00	6.18	17.48	19.69	16.69	0.6	0.31	0.08	176
14"	14.25	20.20	10.63	17.76	21.65	21.65	0.6	0.31	-	242
16"	15.24	21.18	10.63	19.76	23.62	23.62	0.6	0.39	-	275
18"	16.45	22.40	12.20	22.16	23.62	25.20	0.6	0.39	-	385
20"	17.44	23.39	13.78	24.17	23.62	26.77	0.6	0.39	-	440
24"	19.45	25.39	12.59	28.15	23.62	31.49	0.6	0.39	-	633
28"	21.42	27.36	17.72	32.13	-	-	0.8	-	-	728
30"	22.48	28.43	21.89	34.21	-	-	0.8	-	-	794
32"	23.86	29.80	22.05	36.50	-	-	0.8	-	-	992
36"	25.71	31.65	24.80	40.63	-	-	0.8	-	-	1168
40"	27.72	33.85	26.38	44.72	-	-	0.8	-	-	1455
42"	27.72	33.85	26.38	44.72	-	-	0.8	-	-	1455
44"	29.72	35.67	30.31	48.74	-	-	0.8	-	-	2513
48"	31.89	37.83	31.18	53.07	-	-	0.8	-	-	2601
54"	36.42	42.36	39.37	61.97	-	-	0.12	-	-	3528
60"	38.27	44.21	40.15	65.83	-	-	0.12	-	-	5423
66"	40.35	46.30	44.49	69.84	-	-	0.12	-	-	5566
72"	44.21	50.16	49.21	77.72	-	-	0.12	-	-	6460
80"	48.15	54.09	54.13	85.59	-	-	0.12	-	-	8080
88"	53.30	59.03	58.90	94.50	-	-	-	-	-	12544

1) When grounding or protection rings are used, the thickness of the grounding or protection ring must be added to the sensor face-to-face length

2) T_C = Protection ring type C, T_E = Grounding ring type E, T_F = Grounding ring type Flat ring

3) Not according to ISO 20456